



WWW.METRO.COM



We put space to work.™

More choices, better solutions. Advancing the way you work.



The Metro line of healthcare products are constantly in motion. Always advancing in technology. Constantly advancing in efficiencies. Always moving forward with new and better solutions that help improve patient care.

Our MetroCarts™ line features premium solutions with many things in common: our carts are easy to roll for less effort and greater control; each is engineered with greater maneuverability for enhanced ergonomics; all have flexible options created to give you more choices for highly specified tasks; and all are designed to adapt to changing technology for long-term utility and value.



Metro incorporates several elements in its product design to support a facility's infection control processes:

- Microban® antimicrobial protection helps keep products “cleaner between cleanings”
- Advanced polymer and other proprietary finishes provide corrosion resistance
- Smooth rounded corners to allow for easier cleaning

Look for the “red check” symbol for this added protection.

Metro® value-added solutions:

Whether your top priority issues involve storage space, or security, or more efficient transport—our applications specialists can configure a "just right" solution—for you and your patients.

STORAGE AND SPACE ANALYSIS: Metro will provide you with a comprehensive storage and space analysis. We'll make recommendations on how to best use your available space and which cart is right for you. Best of all, this analysis is absolutely free.

QUOTES: In addition to working with your available space, we also work with your budget. We'll provide you with quotes for the most cost-effective solution.

DRAWINGS/LAYOUTS: Based on our storage and space analysis, we can provide you with free layouts and drawings showing the best solution for your situation.

DO IT YOURSELF: Our proprietary Metro Configurator lets you create room layouts and configure alternative scenarios to effectively use your space to best advantage. See for yourself, visit www.metroconfigurator.com

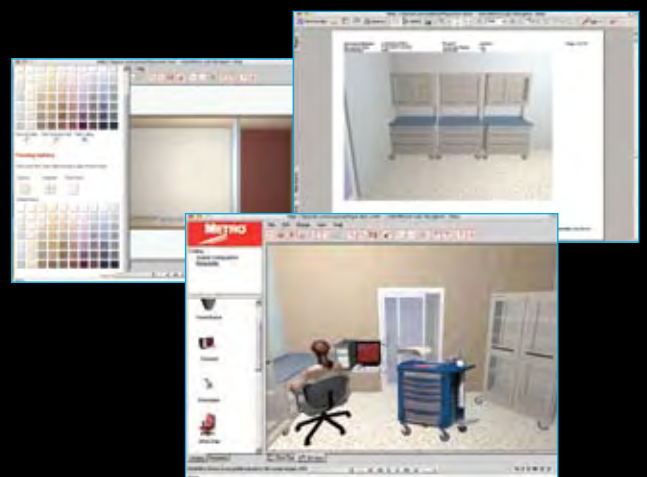

Do it yourself at
metroconfigurator.com



We put space to work.™

TABLE OF CONTENTS

LIFELINE™ Designed for a code. Not adapted for one.

Cart Overview	6-7
Preconfigured Carts	8
Preconfigured Cart Accessory Details	9
Lifeline™ Carts, Drawers, Security, Accessories	10-11

FLEXLINE™ Standardized options. Configured by you.

Cart Overview	12-13
Preconfigured Procedure Carts	14-16
Preconfigured Procedure Cart Accessory Details	17
Flexline™ Carts, Drawers, Security, Accessories	18-21

STARSYS™ Ultimate modularity. Unlimited choices.

Cart Overview	22-23
Preconfigured Procedure Carts	24-25
Starsys™ Carts , Drawers, Security, Accessories	26-30

BASIX™ Traditional materials. Inspired design.

Cart Overview	32-33
Basix Plus™ Preconfigured Carts	34
Basix Plus™ Carts , Drawers, Security, Accessories	35-39
New Carts & Accessories	40-41
Basix™ Preconfigured Carts	42
Basix™ Carts , Drawers, Security, Accessories	43-48



STARSYS™

Ultimate modularity.
Unlimited choices.

STARSYS™
CONFIGURE MORE
WORKSPACE,
STORAGE AND
EFFICIENCY—ALL IN
THE SMALLEST
FOOTPRINT.

- LIGHTWEIGHT POLYMER CONSTRUCTION
- MODULAR BASED, INTERCHANGEABLE SYSTEM
- HIGHLY CUSTOMIZABLE
- BUILT IN ABILITY TO EXPAND



FLEXLINE™

Flexible options.
Designed around you.

FLEXLINE™
FLEXIBLE SOLUTIONS
THAT CONFORM TO
TODAY'S APPLICATION NEEDS ...
AND TOMORROW'S

- LIGHTWEIGHT POLYMER CONSTRUCTION
- ENHANCED SECURITY FEATURES
- SPACIOUS WORKSURFACE
- CONFIGURATIONS THAT FIT YOUR BUDGET





LIFELINE™

Designed for a code.
Not adapted for one.

LIFELINE™
INTEGRATED FEATURES
SPECIFICALLY DESIGNED
FOR CODE RESPONSE.

- LIGHTWEIGHT POLYMER CONSTRUCTION
- QUICK, SAFE TRANSPORT TO CODE
- MULTI-PERSON ACCESS
- HIGHLY ORGANIZED



BASIX™

Traditional materials.
Inspired design.

BASIX PLUS™
A LIGHTER, CLEANER, EASIER
CART SOLUTION.

- LIGHTWEIGHT HYBRID CONSTRUCTION
- CLEANER DESIGN
- ERGONOMIC FEATURES



Lifeline

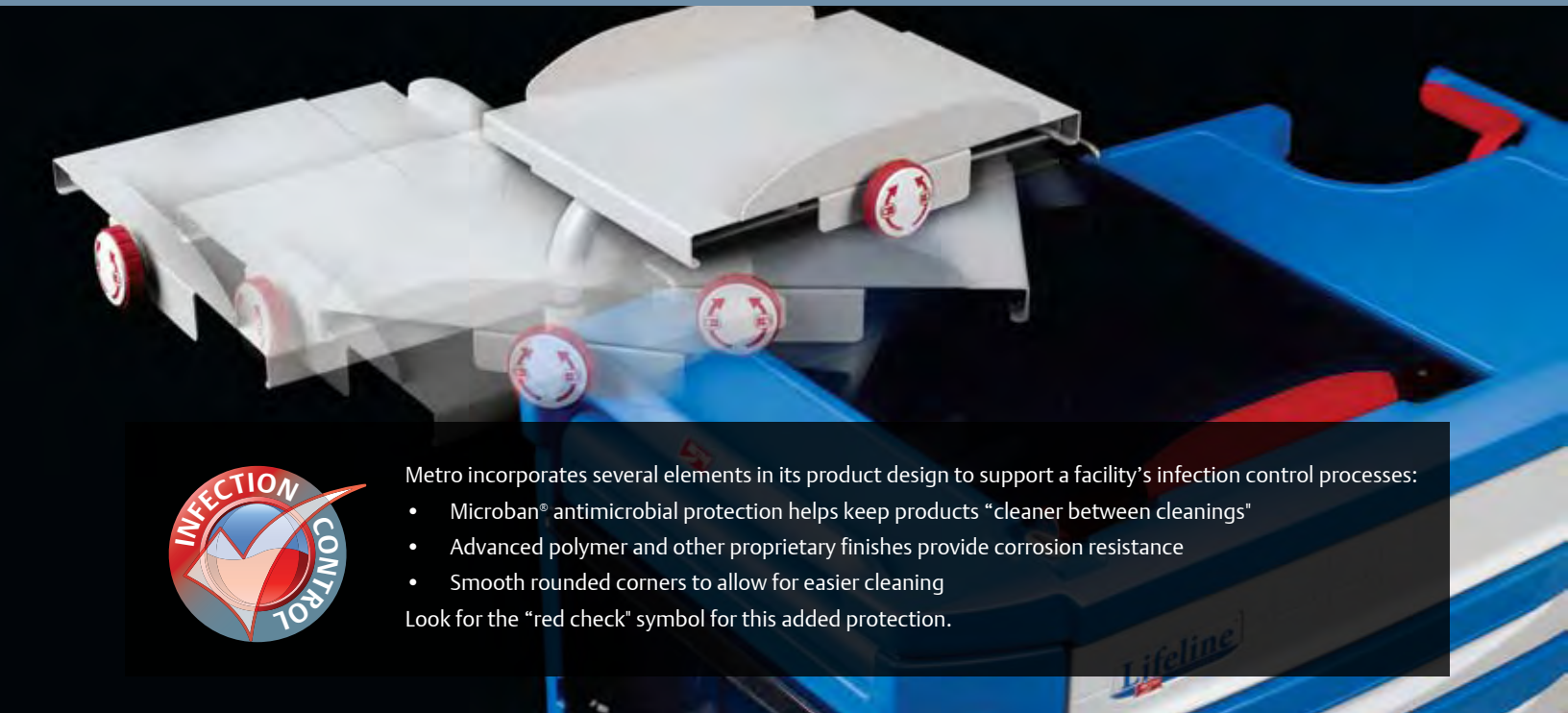

Metro incorporates several elements in its product design to support a facility's infection control processes:

- Microban® antimicrobial protection helps keep products "cleaner between cleanings"
- Advanced polymer and other proprietary finishes provide corrosion resistance
- Smooth rounded corners to allow for easier cleaning

Look for the "red check" symbol for this added protection.

Lifeline. Save lives together!

FIND IT FAST.

Get organized with Lifeline. Drawer dividers and trays make finding critical medications and supplies easy.



BE EFFICIENT.

Have simultaneous access to medications and supplies by multiple code team members.

TAKE CONTROL.

5th wheel steering Assist assures maximum control in transit and maneuverability during a code.

Designed for a code. Not adapted for one.



STANDARD DRAWER PULL COLOR



PEDIATRIC COLOR KIT

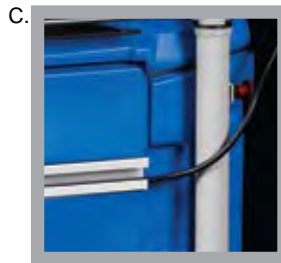
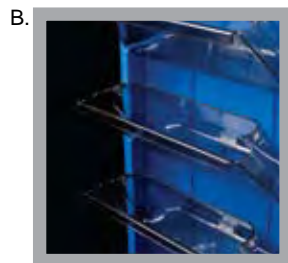

- > Advanced polymer construction, rounded corners and Microban antimicrobial product protection help maintain a cleaner cart to improve infection control.
- A. Lightweight polymer construction, ergonomic handle and proprietary 5th-wheel steering system assures maximum control in transit and maneuverability during a code.
- B. Tilt out side bins, top storage compartment and drawers provide simultaneous access to multiple stored products.
- C. Cord management and restraint system keeps cords neatly organized and protects equipment from accidental damage.
- D. Strapless defibrillator platform adjusts to accommodate various defibrillators.
- E. Swingarm positions defibrillator closer to the patient; clears top work area.
- F. Recessed top storage with a clear removable cover provides instant access to first line meds or airway equipment without impeding access to drawers.
- G. Convenience features include an extendable I.V. Pole, O2 Tank Storage, Suction Pump Shelf, Glove Box Holder, Lockable Sharps Container, Hospital Grade Outlet Strip, Cord Management, Trays & Dividers.
- H. Full extension drawers have self-closing ball bearing slides to provide easy access to medications and supplies. (Drawer depths: 3", 6", 9", 12")
- I. Lock mechanism secures top compartment, drawers and side bins and can be sealed in segments or one seal secures all.
- J. Backboard can be mounted to the front or back of the cart.
- K. Two brake casters positioned in the front of the cart to provide stability.

Packages include cart and accessories.



Code Response Cart **LECCRP2**



Code Response Cart **LECCRP3**



Code Response Cart **LECCRP4**



Code Response Cart **LECCRP5**



Code Response Cart **LECCRP7**



Code Response Cart **LECPEDS2**

Upgradeability.



Basic Cart with side bins and tank holder



Time.
Budget.
Needs.



Upgrade with defibrillator arm, storage bin and suction shelf



Time.
Budget.
Needs.



Upgrade again with drawers, trays & dividers

One of the best features about Lifeline is its upgradeability. Start with a basic model based on budget or current requirements and buy the confidence that it can change as your needs change.

Note: Model Numbers shown for carts with open storage below drawers do not include security mechanism for open space. Contact your Metro Representative for a quotation with secure storage space.

Code Response Preconfigured Carts

Carts shown on the previous pages are configured with the components and accessories listed here.

		Cat. No.	LECRP2	LECRP3	LECRP4	LECRP5	LECRP6	LECRP7	LECRP8	LECPEDS1	LECPEDS2
Accessories											
Model No.	Description										
FL120	Solid Bottom Shelf								X		
LEC143	Top Cavity Tray			X		X	X		X		
FL151	3"(76mm) Drawer Divider Tray With Dividers					1	2				7
FL159	6"(152mm) Drawer Divider Tray With Dividers					1	1				1
FL190	Label Holder Set of 10							X			
FL211	Side Bin (1)- Locking			3	3	3		4	3	2	4
FL221	Waste Basket 28 Quart & Holder		X				X			X	
LEC236	Glove Box Holder - Single (mounts to handle side)					X				X	
LEC251	Lockable Sharps Container (mounts to handle side)		X				X				X
FL302	Cord Manager					X		X			X
LEC304	Adjustable Defibrillator Tray		X	X	X	X	X	X	X	X	X
FL305	Hospital Grade 6-Outlet Strip and Holder							X			X
LEC306	Suction Pump Shelf			X		X		X	X		X
LEC308	Backboard with Front Assembly kit			X	X	X	X		X	X	
LEC309	Backboard with Back Assembly kit		X					X			X
Included	Oxygen Tank Holder		X	X	X	X	X	X	X	X	X
FL315	IV Pole with Cart Mount		X	X	X	X	X	X	X	X	X
LEC319	Storage/Gel Bin			X				X	X		
LEC320	Plastic Security Seals 100PK		X	X	X	X	X	X	X	X	X
FL403	Individual Drawer Seal Lock Bar										X
LEC-PED8	Pediatric Code Response Drawer Kit									X	X
Carts											
Model No.	Description										
LEC24P	39"(991mm) Cart		X	X					X		
LEC27P	42"(1067mm) Cart				X	X					
LEC30P	45"(1143mm) Cart						X	X		X	X
Drawers, with Code Blue* Drawer Pull											
Model No.	Description										
LEC103	3" (76mm) Drawer	1	2	2	3	4	2	2	7	7	
LEC106	6" (152mm) Drawer	3	1	1	1	1	2	1	1	1	
LEC109	9" (203mm) Drawer		1		1	1	1				
LEC112	12"(305mm) Drawer			1							

*Multicolor Drawer Pulls are provided on Pediatric Carts



5th wheel maneuverability.

Lightweight polymer construction, ergonomic handle and proprietary 5th-wheel steering system assures maximum control in transit and maneuverability during a code.



LECP31100

Basic Carts with Drawers

Cart	Drawer Configuration	5th Wheel Steering Assist	Drawer Pull Color	Tank Holder	Cat. No.
39" (991mm)H	1 - 3" (76mm)	X	Code Blue	X	LECP13000
Passive Lock	3 - 6" (152mm)				
42" (1067mm)H	3 - 3" (76mm)	X	Code Blue	X	LECP31100
Passive Lock	1 - 6" (152mm)				
	1 - 9" (230mm)				
45" (1143mm)H	4 - 3" (76mm)	X	Code Blue	X	LECP41100
Passive Lock	1 - 6" (152mm)				
	1 - 9" (230mm)				

Build-a-Cart

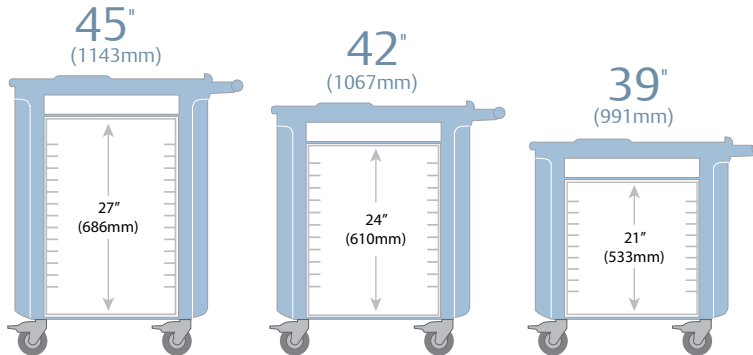

Cart Bodies without Drawers

Width/Length/Height in. (mm)	Storage Space in. (mm)	Drawer Space in. (mm)	Steering Assist	Tank Holder	Cat. No.
23 ¹ / ₈ (587mm)x37 ⁷ / ₈ (962mm)x38 ¹ / ₈ (968mm)	24(610mm)	21(533mm)	X	X	LEC24P
23 ¹ / ₈ (587mm)x37 ⁷ / ₈ (962mm)x41 ¹ / ₂ (1054mm)	27(686mm)	24(610mm)	X	X	LEC27P
23 ¹ / ₈ (587mm)x37 ⁷ / ₈ (962mm)x44 ⁷ / ₈ (1140mm)	30(762mm)	27(686mm)	X	X	LEC30P

Note: Width includes optional backboard holders



STANDARD DRAWER PULL COLOR CODE BLUE

Additional Security

Description	Cat. No.
Individual Drawer Seal Lock Bar - 36" Cart	FL401
Individual Drawer Seal Lock Bar - 39" Cart	FL402
Individual Drawer Seal Lock Bar - 42" Cart	FL403

Drawer and Shelf

Description	Cat. No.
3" (76mm) Pull Out Shelf	FL101
3" (76mm) Drawer with Code Blue Pull	LEC103
6" (152mm) Drawer with Code Blue Pull	LEC106
9" (203mm) Drawer with Code Blue Pull	LEC109
12" (305mm) Drawer with Code Blue Pull	LEC112
Solid Bottom Shelf	FL120
Drawer Kit, Pediatric (7-3" Drawers and 1-6" Drawer)	LEC-PED8*

Inside Drawer Dimensions— 20¹/₄" (514mm) wide x 17" (432mm) deep.

*Can be ordered with a 45" (1142mm) cart body only.



PEDIATRIC DRAWER AND COLOR KIT

(Includes drawers, colored pulls and labels only)

Drawer Accessories

Description	Cat. No.
3" (76mm) Drawer Divider Kit	FL113
Short Divider For LEC103 or FL103 5 PK	FL114
Long Divider For LEC103 or FL103 2 PK	FL115
6" (152mm) Drawer Divider Kit	FL116
Short Divider For LEC106 or FL106 5 PK	FL117
Long Divider for LEC106 or FL106 2 PK	FL118
Ampule Insert & 12 Divider for Top Cavity or 3" (76mm) Drawer Tray	FL131
Divider For FL131, 12 PK	FL132
3" (76mm) Egg Crate Style Drawer Divider Kit	FL141
6" (152mm) Egg Crate Style Drawer Divider Kit	FL142
Top Cavity Tray	LEC143
Hard Lid For LEC143	LEC144
3" (76mm) Drawer Divider Tray With Dividers	FL151
Lid For 6" (152mm) Drawer Tray	FL158
6" (152mm) Drawer Divider Tray With Dividers	FL159
Long Divider Rails For LEC143 or FL151 2 PK	FL163
Short Divider For LEC143 or FL151 10PK	FL164
Long Divider For FL159 (2PK)	FL166
Short Divider For FL159 (3PK)	FL167
Security Bags For 3" (76mm) & 6" (152mm) Trays	FL183
Security Bags For Top Cavity Tray	LEC185
Label Holder Set of 10	FL190



FL211

Right (Handle) Side Accessories

Description	Cat. No.
Glove Box Holder - Single	LEC236
Lockable Sharps Container	LEC251
Replacement Containers for LEC251	FL252
Suction Pump Shelf	LEC306
Oxygen Tank Holder*	-

*Included on all carts



LEC251

Left Side Accessories

Description	Cat. No.
Side Bin (1)- Locking	FL211
Side Bin (1)- Non Locking	FL212
Waste Basket 28 Quart & Holder	FL221
Waste Basket 28 Quart	FL222
Glove Box Holder - Single	FL236
Glove Box Holder - Triple	FL237
Sharps Container Bracket - Non Locking	FL250
Lockable Sharps Container	FL251
Replacement Containers for FL251	FL252



LEC306

Cart Accessories

Description	Cat. No.
Rear Accessory Mount Brackets – 1 Pair	FL301
Cord Manager	FL302
Adjustable Defibrillator Tray	LEC304
Hospital Grade 6-Outlet Strip and Holder	FL305
Backboard with Front Assembly Kit*	LEC308
Backboard with Back Assembly Kit*	LEC309
IV Pole with Cart Mount	FL315
Storage/Gel Bin	LEC319
Plastic Security Seals 100pk	LEC320
Front Mount Backboard Assembly Kit*	LEC321
Back Mount Backboard Assembly Kit*	LEC322
Backboard	LEC323

*Must be factory installed prior to shipment



FL302



LEC309



LEC304



FL305



Flexline



Flexline is constructed of advanced polymers, designed with rounded corners and infused with Microban antimicrobial product protection for a clean, durable solution that withstands the rigors of a healthcare environment.



Metro incorporates several elements in its product design to support a facility's infection control processes:

- Microban® antimicrobial protection helps keep products “cleaner between cleanings”
- Advanced polymer and other proprietary finishes provide corrosion resistance
- Smooth rounded corners to allow for easier cleaning

Look for the “red check” symbol for this added protection.

Standardized options. Configured by you.



DRAWER PULL COLORS



CODE BLUE DRAWER PULL COLOR



PEDIATRIC COLOR KIT



- > Advanced polymer construction, rounded corners and Microban antimicrobial product protection help maintain a cleaner cart to improve infection control.
- A. Pull out side shelf provides additional work space.
- B. Pull out interior shelf accommodates equipment or used as a seated writing surface.
- C. Laptop arm and keyboard shelf accommodate technology needs.
- D. Full extension drawers have self-closing ball bearing slides to provide easy access to medications and supplies. (Drawer depths: 3", 6", 9", 12")
- E. Auto Lock Keyless Entry Touch Pads, Card Readers, Data Manager Software, Key Locks and Passive Locks are available for every security need.
- F. Spacious work surface provides a smooth writing surface or ample space for prep work.
- G. 5" (127mm) polymer caster, 2 directional and 2 brake casters provide control and stability.
- H. Overbridge Storage creates additional space and clears clutter without expanding the cart footprint.
- I. Recessed side storage holds tilt out bins, wastebaskets, lockable sharps containers, O2 tanks, glove boxes, and suction pump shelves.
- J. Strapless defibrillator platform adjusts to fit various defibrillators and can be moved away from work surface and towards the patient.
- K. The backboard can be mounted to the front or back of the cart.
- L. Passive security seals for the entire cart or individual drawers. 13

Packages include carts and accessories.



Code Response Package **FLCRP1**



Code Response Package **FLCRP2**



Code Response Package **FLCRP3**



Code Response Package **FLCRP4**



Code Response Pediatrics **FLPED1**



Anesthesia Package **FLANES1**



Isolation Package **FLISO1**



Isolation Pediatrics **FLISO3**



Bedside Package **FLBED**

Packages include carts and accessories.



Treatment Package **FLTMENT1**



Treatment Package **FLTMENT2**



Procedure Package **FLPROC1**



Procedure Package **FLPROC2**



Cast Package **FLCAST**



Endoscopic Package **FLEND0**



Dressing Package **FLDRS**



Phlebotomy Package **FLIV**



Critical Care Package **FLCCU1**



Med/Surge Package **FLMDSRG**



Central Line Package **FLCLINE**



Airway Package **FLAIR**



Nurse Server Package **FLNURSE**



Optional Technology
Features include:

- Automatic electronic locking systems
- Articulating arms to hold laptops, tablets, and LCD screens
- Retractable keyboard tray
- Internal/external wire management protects cords from snags and damage
- Hospital grade outlet strips
- Tech trays for battery or computer storage

Computer Package **FLCOM-LT**

(Laptop, mouse, and power supply not included.)



Many applications in healthcare today are utilizing a form of technology. Applications that are integrating technology into their process need a cart that can accommodate those components. The needs can range from a simple hospital grade strip and articulating laptop arm, to a fully integrated solution with onboard power and a full complement of technology accessories.

Basic Carts with Drawers



FLNK2210

Cart	Drawer Configuration	Lock	Drawer Pull Color	Cat. No.
36" (914mm)H Standard	2 - 3" (76mm)	Key Lock	Violet	FLK21100
	1 - 6" (152mm)			
	1 - 9" (229mm)			
36" (914mm)H Narrow	3 - 3" (76mm)	Key Lock	Pink	FLNK3200
	2 - 6" (152mm)			
39" (991mm)H Standard	3 - 3" (76mm)	Passive Lock	Red	FLP31100
	1 - 6" (152mm)			
	1 - 9" (229mm)			
42" (1067mm)H Narrow	2 - 3" (76mm)	Key Lock	Slate Blue	FLNK22100
	2 - 6" (152mm)			
	1 - 9" (229mm)			
42" (1067mm)H Standard	4 - 3" (76mm)	Passive Lock	Slate Blue	FLP41100
	1 - 6" (152mm)			
	1 - 9" (229mm)			
42" (1067mm)H Narrow	3 - 9" (229mm)	Key Lock	Dark Taupe	FLNK00300
45" (1143mm)H Standard	2 - 3" (76mm)	Passive Lock	Orange	FLP22010
	2 - 6" (152mm)			
	1 - 12" (305mm)			
45" (1143mm)H Narrow	1 - 3" (76mm)	Passive Lock	Green	FLNP13100
	3 - 6" (152mm)			
	1 - 9" (229mm)			

Build-a-Cart

STANDARD CART

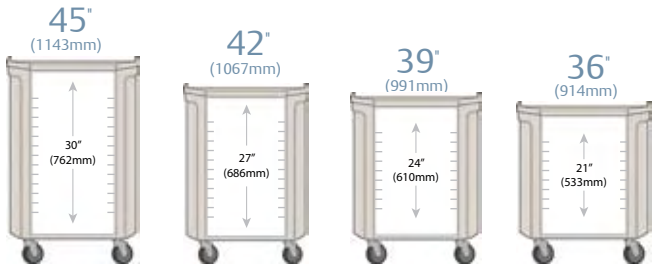

NARROW CART

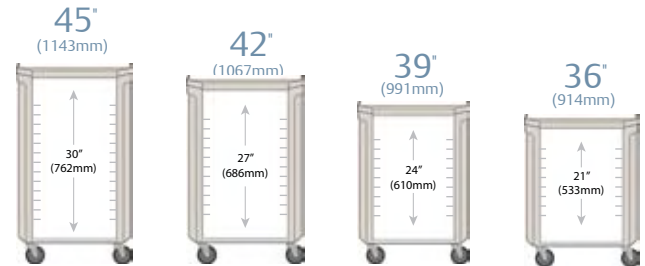

Cart Bodies without Drawers

Width/Length/Height in. (mm)	Drawer Space in. (mm)	Lock	Width	Cat. No.
22 ³ / ₈ (568mm) x32 ¹ / ₄ (819mm) x34 ⁷ / ₈ (886mm)	21" (533mm)	Passive Lock	Standard	FL21P
22 ³ / ₈ (568mm) x32 ¹ / ₄ (819mm) x38 ¹ / ₈ (969mm)	24" (610mm)	Passive Lock	Standard	FL24P
22 ³ / ₈ (568mm) x32 ¹ / ₄ (819mm) x41 ¹ / ₂ (1054mm)	27" (686mm)	Passive Lock	Standard	FL27P
22 ³ / ₈ (568mm) x32 ¹ / ₄ (819mm) x44 ⁷ / ₈ (1140mm)	30" (762mm)	Passive Lock	Standard	FL30P
22 ³ / ₈ (568mm) x28 ⁷ / ₈ (734mm) x34 ⁷ / ₈ (886mm)	21" (533mm)	Passive Lock	Narrow	FLN21P
22 ³ / ₈ (568mm) x28 ⁷ / ₈ (734mm) x38 ¹ / ₈ (969mm)	24" (610mm)	Passive Lock	Narrow	FLN24P
22 ³ / ₈ (568mm) x28 ⁷ / ₈ (734mm) x41 ¹ / ₂ (1054mm)	27" (686mm)	Passive Lock	Narrow	FLN27P
22 ³ / ₈ (568mm) x28 ⁷ / ₈ (734mm) x44 ⁷ / ₈ (1140mm)	30" (762mm)	Passive Lock	Narrow	FLN30P
22 ³ / ₈ (568mm) x32 ¹ / ₄ (819mm) x34 ⁷ / ₈ (886mm)	21" (533mm)	Key Lock	Standard	FL21K
22 ³ / ₈ (568mm) x32 ¹ / ₄ (819mm) x38 ¹ / ₈ (969mm)	24" (610mm)	Key Lock	Standard	FL24K
22 ³ / ₈ (568mm) x32 ¹ / ₄ (819mm) x41 ¹ / ₂ (1054mm)	27" (686mm)	Key Lock	Standard	FL27K
22 ³ / ₈ (568mm) x32 ¹ / ₄ (819mm) x44 ⁷ / ₈ (1140mm)	30" (762mm)	Key Lock	Standard	FL30K
22 ³ / ₈ (568mm) x28 ⁷ / ₈ (734mm) x34 ⁷ / ₈ (886mm)	21" (533mm)	Key Lock	Narrow	FLN21K
22 ³ / ₈ (568mm) x28 ⁷ / ₈ (734mm) x38 ¹ / ₈ (969mm)	24" (610mm)	Key Lock	Narrow	FLN24K
22 ³ / ₈ (568mm) x28 ⁷ / ₈ (734mm) x41 ¹ / ₂ (1054mm)	27" (686mm)	Key Lock	Narrow	FLN27K
22 ³ / ₈ (568mm) x28 ⁷ / ₈ (734mm) x44 ⁷ / ₈ (1140mm)	30" (762mm)	Key Lock	Narrow	FLN30K



FL420

Additional Security

Description	Cat. No.
Individual Drawer Seal Lock Bar - 36" (914mm) Cart	FL400
Individual Drawer Seal Lock Bar - 39" (991mm) Cart	FL401
Individual Drawer Seal Lock Bar - 42" (1067mm) Cart	FL402
Individual Drawer Seal Lock Bar - 45" (1143mm) Cart	FL403
Basic Keyless Entry Touch Pad with 10 year battery	FL410*
Basic Keyless Entry Touch Pad with Auto Lock, Rechargeable	FL411*
Touch Pad Charger Adapter Kit - 90-264 VAC 47-63 Hz	FL419
Touchpad with LCD Screen, Auto Lock, USB Port (Card Reader Upgradable)	FL420*
Software Manager for FL420	FL421
Proximity Card Reader for FL420	FL430**
Bar Code Card Reader for FL420	FL431**
Magnetic Card Reader for FL420	FL432**

*FL410, FL411, FL420 can only be ordered with a key locking cart.
**Readers may not be compatible with all cards. Check with your Metro Representative.

Drawer, Shelf and Keyboard Shelf Drawer pulls must be ordered with each drawer.

Description	Cat. No.
Lockable Drawer Cover	FL100
3" (76mm) Pull Out Shelf	FL101
Keyboard Tray	FL102
3" (76mm)Narcotics Box/Individual Locking Drawer	FL103L
3" (76mm) Drawer (no drawer pull)	FL103
6" (152mm) Drawer (no drawer pull)	FL106
9" (229mm) Drawer (no drawer pull)	FL109
12" (305mm) Drawer (no drawer pull)	FL112
Solid Bottom Shelf	FL120
Pediatric Code Response Drawer Kit (8-3", 1-6" Drawers with colored pulls)	FL-PED9**

*Inside Drawer Dimensions- 20 7/16" (514mm) wide x 17" (432mm) deep.
**Can only be ordered with a 45" cart.

Drawer Pulls Colors Order 1 drawer pull per drawer.

Description	Cat. No.
Drawer Pull - Code Blue	FL-CB
Drawer Pull - Red	FL-RD
Drawer Pull - Orange	FL-OR
Drawer Pull - Green	FL-GR
Drawer Pull - Yellow	FL-YL
Drawer Pull - Slate Blue	FL-SB
Drawer Pull - Violet	FL-VL
Drawer Pull - Pink	FL-PK
Drawer Pull - White	FL-WHT
Drawer Pull - Dark Taupe	FL-TPE

DRAWER PULL COLORS

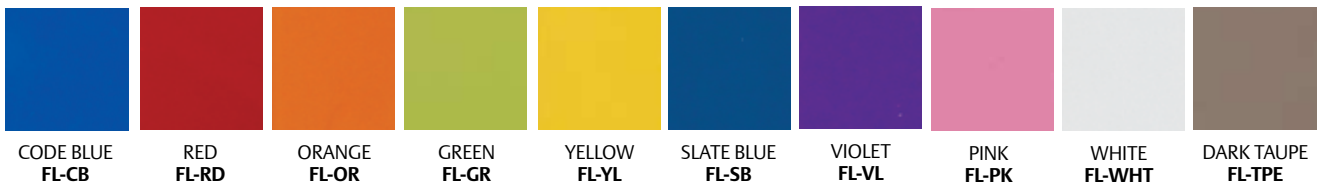

CODE BLUE **FL-CB** RED **FL-RD** ORANGE **FL-OR** GREEN **FL-GR** YELLOW **FL-YL** SLATE BLUE **FL-SB** VIOLET **FL-VL** PINK **FL-PK** WHITE **FL-WHT** DARK TAUPE **FL-TPE**



FL400-FL403



FL101



FL102

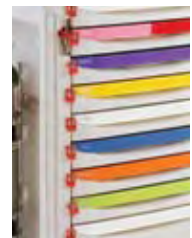

FL-PED9



FL151



FL159



FL190 (Label not included)

Drawer Accessories

Description	Cat. No.
3" (76mm)Drawer Divider Kit	FL113
Short Divider For FL103 or LEC103 5 PK	FL114
Long Divider Rails For FL103 or LEC103 2 PK	FL115
6/9" (152/229mm) Drawer Divider Kit	FL116
Short Divider For FL106 or LEC106 5 PK	FL117
Long Divider Rails For FL106 or LEC106 2 PK	FL118
Ampule Insert & 12 Divider For 3" (76mm) Drawer Tray	FL131
Divider For FL131, 12 PK	FL132
3" (76mm)Egg Crate Style Drawer Divider Kit	FL141
6" (152mm)Egg Crate Style Drawer Divider Kit	FL142
3" (76mm) Drawer Divider Tray With Dividers	FL151
Lid For 6"(152mm) Drawer Tray	FL158
6" (152mm) Drawer Divider Tray With Dividers	FL159
Long Divider For FL151 or LEC143 2 PK	FL163
Short Divider For FL151 or LEC143 10PK	FL164
Long Divider For FL159 2 PK	FL166
Short Divider For FL159 3 PK	FL167
Security Bags For 3" (76mm)Tray and 6" (152mm)Tray 20PK	FL183
Label Holder Set of 10	FL190



FL237



FL235



FL236, FL221



FL212

Side/Recessed Storage Accessories

Description	Cat. No.
Side Bin (1)- Locking	FL211*
Side Bin (1)- Non Locking	FL212
Waste Basket 28 Quart & Holder	FL221
Waste Basket 28 Quart	FL222
O2 Tank Holder - 45"(1140mm)H Cart - 5 1/2" Diameter Tank	FL235-5**
O2 Tank Holder - 45"(1140mm)H Cart - 4" Diameter Tank	FL235**
Glove Box Holder - Single	FL236
Glove Box Holder - Triple	FL237
Scope Cabinet, 2 - hook	FL245
Scope Cabinet, 4 - hook	FL246
Sharps Container Bracket - Non Locking	FL250
Lockable Sharps Container	FL251
Replacement Containers for FL251	FL252

*Locking bins for keylock cart are available on the right. Locking bins for the passive lock cart are available on the left.

**Please call for tank storage on carts lower than 45" (1143mm)



FL314



LEC304, FL315



FL303

Cart Accessories

Description	Cat. No.
Rear Accessory Mount Brackets – 1 Pair	FL301
Cord Manager	FL302
Defibrillator Strap Kit	FL303
Adjustable Defibrillator Tray	LEC304
Hospital Grade 6-Outlet Strip and Holder	FL305
Suction Pump Shelf	LEC306
Backboard with Front Assembly Kit	LEC308*
Backboard with Back Assembly Kit	LEC309*
Articulating arm - Laptop	FL310
Articulating arm - Tablet	FL311
Articulating arm - Monitor	FL318
Peel Pouch Container	FL312
Peel Pouch/Catheter Holder	FL313
Pull Out Side Shelf	FL314
2HK IV pole With Cart Mount	FL315
4HK IV pole With Cart Mount	FL317
Plastic Security Seals 100PK	LEC320
Front Mount Backboard Assembly Kit	LEC321*
Back Mount Backboard Assembly Kit	LEC322*
Backboard	LEC323

*Must be factory installed.



FL310



FL515, FL544

Over Bridges & Over Bridge Accessories

Description	Cat. No.
Over Bridge With 2 Hanger Rails	FL510
Over Bridge With Top Shelf & Hanger Rail	FL515
Over Bridge With 2 Shelves	FL520
Tilt Bin 3 For Over Bridge - 9½"(241mm)Hx7¾"(197mm)Wx23¾"(600mm)L	FL543
Tilt Bin 4 For Over Bridge - 8¼"(206mm)Hx6¼"(168mm)Wx23¾"(600mm)L	FL544
Tilt Bin 6 For Over Bridge - 4½"(114mm)Hx3¼"(92mm)Wx23¾"(600mm)L	FL546
Hanger Rail	FL550
Over Bridge Bottom Shelf	FL559
Over Bridge Top Shelf	FL560
2HK IV Pole With Universal Clamp - For Over Bridge	FL563
4HK IV Pole With Universal Clamp - For Over Bridge	FL566
Universal Clamp	FL570
Short Utility Hook 4 PK (Holds peel pouches, IV bags, stethoscopes, etc..)	FL571*
4-Hook Rack (Holds forceps and scopes)	FL574
Laryngoscope Blade/Specimen Bag Holder (Holds plastic bag -not included- for safe storage of contaminated items)	FL575*
Chart Holder	FL576
Half-Size Utility Bin - 5½"(140mm)Hx5½"(140mm)Wx5¾"(146mm)L	FL581
Full-Size Utility Bin - 5½"(140mm)Hx5½"(140mm)Wx11¼"(292mm)L	FL582
Label/Tape Dispenser	FL583
Sharps Bracket Container	FL584*
Wire Supply Basket - 5"(127mm)Hx7"(178mm)Wx17"(432mm)L	FL585
Utility Bin With Cover (pack of six)	FL586
Monitor mounts For Over Bridge	FL590

*Fits on universal clamp in addition to a hanger rail.



FL510, FL546, FL544



FL510, FL583, FL581,
FL582, FL586

Starsys

STARSYS™ SYSTEM OVERVIEW



The Starsys Modular System creates flexible space.

No matter what you need — open, closed, short, tall, mobile, stationary, preconfigured WorkCenters or carts . . . Starsys is the product for you.

With Starsys, you choose from an array of modular units to fit the space and work specifications. It's that easy and that flexible.

Starsys Benefits:

- Facilitates fast, efficient product installation.
- The ability to easily reconfigure your furniture layout as needs change.
- The ability to reconfigure unit design.
- Flexibility to design a storage solution to meet your needs.
- Corrosion-proof polymer components for a contamination-free product.
- Durable, easy-to-clean, polymer enclosures that won't chip, dent or rust ever.
- Rigid aluminum and epoxy-coated metal substructure combined with advanced polymers provides a robust stable work environment for even the most sensitive equipment.
- A high level of organization with easy access to supplies.
- Greater storage density in a smaller footprint.

Ultimate modularity Unlimited choices.

DRAWER PULL COLORS

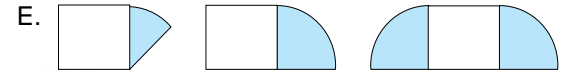

135% more space.

> Lightweight advanced polymer construction, easy-to-clean surfaces and small footprint make Starsys an ideal cart for any clinical application.

A. Keyless entry system features auto relock and access denied functions.

B. Removable drawer totes provide a convenient exchange system.

C. Secure cassettes and bins are convenient for organizing smaller items like medications, needles, and syringes.

D. Overbridge keeps supplies and equipment readily accessible.

E. Swingout worksurfaces can more than double your workspace.

F. Swingout side storage brings all supplies within easy reach.

G. Two brake casters provide stability when needed.

H. Integrated push handle provides ergonomic control.

I. Full extension drawers are easily reconfigured without tools.



40"

Close-up
of system



General Supply
Cat. No. **SXS40CM1**



Isolation
Cat. No. **SXSISO**



Med Surg
Cat. No. **SXSMDSRG**



Dressing
Cat. No. **SXSDRS**



Laptop Ready Cart
(Keyboard not included)
Cat. No. **SXSK1120L**



Laptop Ready Cart
(Keyboard not included)
Cat. No. **SXSK2210L**



Laptop Ready Cart
(Keyboard not included)
Cat. No. **SXSK4110L**

43"



Bedside Cart
Cat. No. **SXS43CM1**



Nurse Server
Cat. No. **SXS43CM3**



General Supply
Cat. No. **SXS43CM4**



General Supply
Cat. No. **SXS43CM5**



General Supply
Cat. No. **SXS43CM6**



Difficult Airway
Cat. No. **SXSAIR1**



Anesthesia
Cat. No. **SXSANES**



Bedside
Cat. No. **SXSBED**

43"



Decentralized Medication
Cat. No. **SXSDCMED**



Arthroscopic
Cat. No. **SXSARTH**



General Procedure
Cat. No. **SXS43CM2**



I.V. Therapy
Cat. No. **SXSIV**



Laparoscopic
Cat. No. **SXSLAP**



Unit Dose Medication
Cat. No. **SXSUDOSE**



Trauma
Cat. No. **SXSTRAMA**

46"



Biomedical
Cat. No. **SXS BIO**



Critical Care
Cat. No. **SXS CCU**



Cast
Cat. No. **SXS CAST**

Basic Single Wide, Locking Carts

Overall Dimensions		Drawer Configuration	Cat. No.
Width/Length/Height (in.)	(mm)		
24 ⁷ / ₈ x22 ¹ / ₁₆ x39 ³ / ₄	632x576x1010	1-3", 3-6", 1-9", 0-12"	SXS1310L
24 ⁷ / ₈ x22 ¹ / ₁₆ x39 ³ / ₄	632x576x1010	3-3", 2-6", 1-9", 0-12"	SXS3210L
24 ⁷ / ₈ x22 ¹ / ₁₆ x39 ³ / ₄	632x576x1010	5-3", 1-6", 1-9", 0-12"	SXS5110L
24 ⁷ / ₈ x22 ¹ / ₁₆ x42 ³ / ₄	632x576x1086	1-3", 2-6", 2-9", 0-12"	SXS1220L
24 ⁷ / ₈ x22 ¹ / ₁₆ x42 ³ / ₄	632x576x1086	4-3", 2-6", 1-9", 0-12"	SXS4210L
24 ⁷ / ₈ x22 ¹ / ₁₆ x42 ³ / ₄	632x576x1086	6-3", 1-6", 1-9", 0-12"	SXS6110L
24 ⁷ / ₈ x22 ¹ / ₁₆ x45 ³ / ₄	632x576x1162	0-3", 3-6", 2-9", 0-12"	SXS0320L
24 ⁷ / ₈ x22 ¹ / ₁₆ x45 ³ / ₄	632x576x1162	2-3", 2-6", 2-9", 0-12"	SXS2220L
24 ⁷ / ₈ x22 ¹ / ₁₆ x45 ³ / ₄	632x576x1162	3-3", 3-6", 1-9", 0-12"	SXS3310L

Carts shown in chart have taupe pulls. Images are shown with blue pulls.



SXS1310L

SXS3210L

Components – Polymer

Description	Inside Dimensions Height/Width/Length (in.)	Non-Locking Cat. No.	Locking Cat. No.
Polymer Drawers (Drawer pull required – see selection below)			
3" (76mm) SW Drawer	2 ³ / ₈ x16 ³ / ₈ x15 ⁷ / ₈	SXS3	SXS3-LK
4.5" (114mm) SW Drawer	3 ⁷ / ₈ x16 ³ / ₈ x15 ⁷ / ₈	SXS4.5	
6" (152mm) SW Drawer	5 ³ / ₈ x16 ¹ / ₄ x15 ³ / ₄	SXS6	SXS6-LK
7.5" (191mm) SW Drawer	6 ⁷ / ₈ x16 ¹ / ₄ x15 ³ / ₄	SXS7.5	
9" (230mm) SW Drawer	8 ³ / ₈ x16 ¹ / ₄ x15 ³ / ₄	SXS9	SXS9-LK
10.5" (267mm) SW Drawer	9 ⁷ / ₈ x16 ¹ / ₄ x15 ³ / ₄	SXS10.5	
12" (305mm) SW Drawer	11 ³ / ₈ x16 ¹ / ₄ x15 ³ / ₄	SXS12	



SXS4210L

SXS3310L

Drawer Pulls (one required per drawer)

To specify color for drawer pull, order following catalog numbers for each drawer:

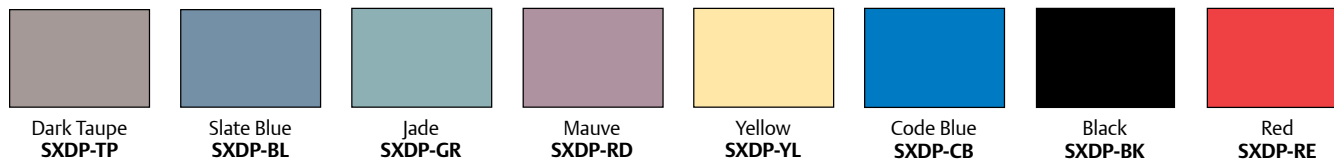

Dark Taupe
SXDP-TP

Slate Blue
SXDP-BL

Jade
SXDP-GR

Mauve
SXDP-RD

Yellow
SXDP-YL

Code Blue
SXDP-CB

Black
SXDP-BK

Red
SXDP-RE

Security Options



Electronic TouchPad

Electronic TouchPad (Keyless Drawer Lock)

For use with low profile, single wide, locking carts. Three user-programmable PIN numbers. Programmable automatic relock function. Programmable access-denied function. Cat. No. **SXSTP-B**

Contact your Metro representative for more information.



Tamper-Evident Locks

Tamper-Evident Locks

Description	Cat. No.
24" (610mm) Security Bar, Drawer Tabs & Seals	SXPSLK-24
27" (686mm) Security Bar, Drawer Tabs & Seals	SXPSLK-27
30" (762mm) Security Bar, Drawer Tabs & Seals	SXPSLK-30
33" (839mm) Security Bar, Drawer Tabs & Seals	SXPSLK-33
36" (914mm) Security Bar, Drawer Tabs & Seals	SXPSLK-36



Electronic Push Button Lock

Electronic Push Button Locks

The electronic push button lock is a simple battery operated lock. It has a ten-digit keypad with three user programmable PIN numbers.

Note: Electronic Push Button Lock takes up the top 3" of cart space and comes standard with key override.

Contact your Metro representative for more information and pricing.

Drawer Accessories for Drawers and Full Extension Totes

Description	Product Detail (Qty.) in.	Cat. No.
Drawer Divider Kits		
3" (76mm) Drawer Divider Kit	(2) 16.8 & (6) 5	SX3DIV
3" (76mm) Drawer Short Dividers	(3) 5	SX3SDIV
3" (76mm) Drawer Long Dividers	(2) 16.8	SX3LDIV
Egg Crate Style 3" (76mm) Drawer Divider Kit	(5) 16.8 & (10) 8	SX3DVR
6" (76mm) Drawer Divider Kit	(2) 16.8 & (6) 5	SX6DIV
6" (76mm) Drawer Short Dividers	(3) 5	SX6SDIV
6" (76mm) Drawer Long Dividers	(2) 16.8	SX6LDIV
Egg Crate Style 6"/9" (152/230mm) Drawer Divider Kit	(5) 16.8 & (10) 8	SX6DVR

Description	Inside Dimensions Height/Width/Length (in.)	Height/Width/Length (mm)	Non-Locking Cat. No.	Locking Cat. No.
Additional Starsys Totes — Totes provide complete containment for smaller items.				
3" (76mm) Drawer Tote	2 ³ / ₄ x 18 ¹ / ₄ x 17 ¹ / ₂	70x464x445	SX3TOTE	SX3-LKTOTE
6" (152mm) Drawer Tote	5 ³ / ₄ x 18 ¹ / ₄ x 17 ¹ / ₂	146x464x445	SX6TOTE	SX6-LKTOTE
9" (229mm) Drawer Tote	8 ¹ / ₂ x 18 ¹ / ₄ x 17 ¹ / ₂	216x464x445	SX9TOTE	SX9-LKTOTE

Description	Dimensions Height/Length in.	Cat. No.
Drawer Label Kit		
Label Kits	1"H.x16"L.	SXLABKIT

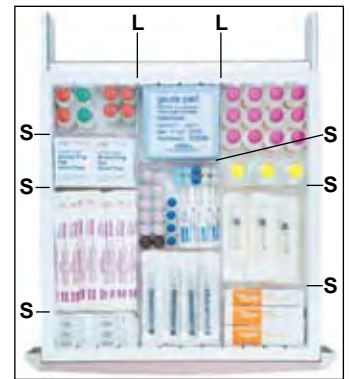

Drawer dividers are available to organize your supplies for easy access.



Removable drawer totes allow for exchange or convenient access outside of cart



Adapt & Reconfigure.

Starsys is the only cart that will allow you to easily reconfigure drawers in your facility without the use of tools. This feature allows you to easily move more frequently accessed drawers to the top of the cart.



Drawer Totes



Drawer Label Kit

Metro Tip:

Accessorize to order is for budgetary purpose. Formal pricing is available through configurator and/or quotation.



Side Storage Unit with one SXPODTRY, two SXTLTBIN and one SXSHRPS



SX205, SX251



SX243



SX246



XPULLOUTL



SXEHAN 28

Side-Mounted Accessories

Description	Cat. No.
Side Storage Units and Accessories	
Stationary Side Storage Assembly without Door (30" [760mm] H.x19 ¹ / ₂ " [495mm] W.x6" [152mm] L.)	SXPOD
Stationary Side Storage Assembly with Door (30" [760mm] H.x19 ¹ / ₂ " [495mm] W.x6" [152mm] L.)	SXPODR
Left-Hand Swing-out Side Storage Assembly without Door (30" [760mm] H.x19 ¹ / ₂ " [495mm] W.x6" [152mm] L.)	SXPODSL
Left-Hand Swing-out Side Storage Assembly with Door (30" [760mm] H.x19 ¹ / ₂ " [495mm] W.x6" [152mm] L.)	SXPODSL D
Right-Hand Swing-out Side Storage Assembly without Door (30" [760mm] H.x19 ¹ / ₂ " [495mm] W.x6" [152mm] L.)	SXPODSR
Right-Hand Swing-out Side Storage Assembly with Door (30" [760mm] H.x19 ¹ / ₂ " [495mm] W.x6" [152mm] L.)	SXPODSR D
Side Storage Unit Tray and Divider Assembly (2 ¹ / ₂ " [57mm] H.x16 ⁷ / ₈ " [428mm] W.x4 ³ / ₈ " [111mm] L.)	SXPODTRY†
Side Pod Shelf (4 ³ / ₁₆ " [106mm] D.x16 ⁷ / ₈ " [429mm] W.)	SXFULSHLF
Tilt-out/Removable Bin (Max. 4 without door; 3 with door) (6" [152mm] H.x3 ³ / ₄ " [95mm] W.x16 ¹ / ₈ " [411mm] L.)	SXTLTBIN†
Cup Holder (Used with tilt-out bins only)**	SXCUP

† Recommend using SXPODTRY or SXFULSHLF to cover top bin.

** Holds 1³/₈" (35mm), 2" (51mm) and 2¹/₂" (64mm) diameter cups.

Swing-out Side Storage Assemblies may be configured on low-profile closed carts only.

Description	Dimensions: Height/Width/Length (in.)	(mm)	Approx. Pkd. Wt. (lbs.) (kg)	Cat. No.
Side Mount Brackets and Accessories (for SX205 only)				
Accessory Direct-Mount Bracket (Qty. 1)				SX205
Suction Unit Shelf	15"W.x10 ³ / ₄ "L.	381x273		SXMF605
Scope Cabinet, 2 — Hook	48"H.x9"W.x6"L.	1220x229x152		SX245
Scope Cabinet, 4 — Hook	48"H.x16"W.x6"L.	1220x406x152		SX246
3 Side Bins — Each Bin	4x4 ¹ / ₂ "x18 ³ / ₈ "	102x114x254	13 5.9	MBP216
Glove Box Holder	10x3 ³ / ₄ "x5 ³ / ₄ "	254x95x146	2 .91	MBA215*

Description	Cat. No.
Accessories for both Side Storage Units, Side Brackets, and Side Pods	
Peel Pouch/Catheter Holder 19" (483mm)	SX240
Peel Pouch/Catheter Holder 28" (711mm)	SX243
Lockable Sharps Cabinet with Glove Box Holder, 1 Container 5 Qt. (4.7L.) (24 ¹ / ₄ " [616mm]H.x13" [330mm] W.x5 ¹ / ₂ " [140mm] L.)	SX251†
Replacement Containers for SX251, Carton of 20, 5 Qt. (4.7L.)	SXMF252
Wastebasket Only	MF222
Waste Basket — Beige (14 ¹ / ₂ " [368mm] H.x10 ¹ / ₂ " [267mm] W.x5" [127mm] L.)	SXBSKT
Waste Basket (Beige) and Holder (15 ¹ / ₄ " [388mm] H.x10 ¹ / ₂ " [267mm] W.x5" [127mm] L.)	SXBSKT-H†
Chart Holder (9 ⁹ / ₁₆ " [242mm] H.x11 ¹ / ₂ " [292mm] W.x4 ³ / ₄ " [121mm] L.)	SXCHRT
Gas Cylinder Holder — Single (for Stationary Units only)	SXGAS-H
Sharps Container Holder (9 ⁵ / ₁₆ " [237mm] H.x9 ¹ / ₂ " [241mm] W.x3 ¹ / ₄ " [83mm] L.)	SXSHRPS†

† Cannot be used on side storage assembly with door.

Description	Cat. No.
Pull-Out Worksurface (must have a drawer pull specified.)	
Side Shelf, Left (Order shelf pull color from page 142)	SXPULLOUTL
Side Shelf, Right (Order shelf pull color from page 142)	SXPULLOUTR**
Extended Handle	
Extended Handle Assembly 4" ([102mm] H.x21 ¹ / ₂ " [546mm] W.x 4 ¹ / ₄ " [108mm] L.)	SXEHAN
Extended Handle Assembly — KD	SXEHAN-KD

** Not available with locking unit.

Overbridge and Accessories

Description	Cat. No.
(A) Overbridge Assembly with two Hanger Rails**	SXSOB
Overbridge Assembly with no Hanger Rails	SXSOB-1000
(B) Hanger Rail (2 ³ / ₁₆ " [55mm] H.x1" [25.4mm] W.x19 ¹ / ₂ " [495mm] L. usable space	SXOBSRAIL
Overbridge with Top Shelf and Hanger Rail	SX515
Overbridge with 2 Shelves	SX520
Overbridge Shelf***	SX560
(C) Utility Pole Including Universal Clamp (Attaches to Overbridge)	SX566
(D) Universal Clamp	SX570
Short Utility Hook (package of 4) (3 ¹ / ₂ " [89mm] usable length)	SX571
Laryngoscope Blade/Specimen Holder	SX575
(E) Half-Size Metal Utility Bin (5 ¹ / ₂ " [140mm] H.x5 ¹ / ₂ " [140mm] W.x5 ³ / ₄ " [146mm] L.)	SX581
(F) Full-Size Metal Utility Bin (5 ¹ / ₂ " [140mm] H.x5 ¹ / ₂ " [140mm] W.x11 ⁵ / ₈ " [292mm] L.)	SX582
Label/Tape Dispenser	SX583
Wire Supply Basket (7" [178mm] H.x5" [127mm] W.x17" [432mm] L.)	SX585
(G) Utility Bin with Cover (Package of 6)	SX586
† Sharps Container Bracket	MF584
†† Sharps Container Bracket	LEC9800
Tilt Bin 3 Units with Brackets	SXMF543
Tilt Bin 4 Units with Brackets	SXMF544
Tilt Bin 6 Units with Brackets	SXMF546

** Maximum weight capacity for overbridge assembly is 40 lbs. (18.1kg).

*** Maximum weight capacity for overbridge shelf is 40 lbs. (18.1kg).

† Mounts to universal clamp in addition to hanger rail.

†† Mounts to I.V. pole or utility pole.

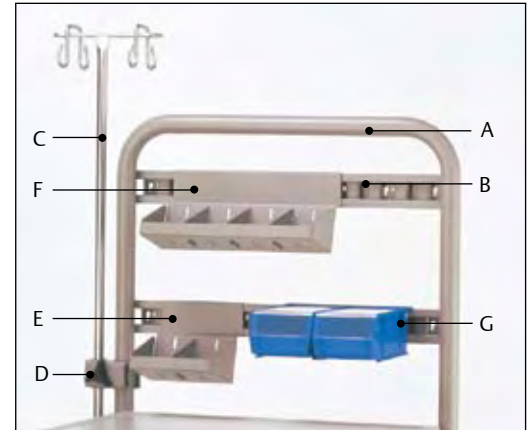

SXSOB Overbridge Assembly (shown with optional accessories)



SXIV

Corner-Mounted Accessories

Description	Cat. No.
Hospital Grade 6-Outlet Strip 15' (4572mm)	SX595
Utility Pole	SXIV

Technology Accessories

Technology comes in many forms and have various means for integration onto a cart. With the modular nature of Starsys we have many solutions for mounting computers, tablets, monitors, keyboards and even power supplies.

Our convenience accessories include:

- Notebook/laptop arms
- Tablet arms
- Monitor arms
- Keyboard Tray
- Notebook/Laptop Tray
- Battery Tray
- Hospital Grade Outlet Strip

Please contact us for a solution customized to your technology



Photo above shows one variation with a laptop imbedded in the cart and an external monitor and keyboard for larger viewing and convenience.

Starsys™ Bin Access Cassette System—
Access a single bin or a full level.

Cassette shown in
“Single Bin Access” Mode



Cassette shown in
“Full Level” Mode



4 Level Cassette with Bins



Bins



Double-Wide, Double Sided Medication Cassette Transfer Cart
Cat. No. SXD43TRAN (shown with cassettes and bins, sold separately, see above)

Components — Polymer

Description	No. of Bins Per Level	Overall Dimensions		Cat. No.
		Height/Width/Length (in.)	Height/Width/Length (mm)	
Cassettes and Bins				
1 Level Cassette Body		5 ¹⁵ / ₁₆ x11 ³ / ₄ x19 ³ / ₈	151x298x492	SXCASB1
2 Level Cassette Body		8 ⁵ / ₁₆ x11 ³ / ₄ x19 ³ / ₈	277x298x492	SXCASB2
3 Level Cassette Body		11 ¹⁵ / ₁₆ x11 ³ / ₄ x19 ³ / ₈	303x298x492	SXCASB3
4 Level Cassette Body		14 ¹⁵ / ₁₆ x11 ³ / ₄ x19 ³ / ₈	379x298x492	SXCASB4
5 Level Cassette Body		17 ¹⁵ / ₁₆ x11 ³ / ₄ x19 ³ / ₈	456x298x492	SXCASB5
3" (76mm) wide Cassette Bin	6	2 ⁹ / ₁₆ x11 ¹⁵ / ₁₆ x2 ¹¹ / ₁₆	65x303x68	SXBINSB3
4 ¹ / ₂ " (114mm) wide Cassette Bin	4	2 ⁹ / ₁₆ x11 ¹⁵ / ₁₆ x4 ¹ / ₁₆	65x303x103	SXBINSB4
6" (152mm) wide Cassette Bin	3	2 ⁹ / ₁₆ x11 ¹⁵ / ₁₆ x5 ¹ / ₂	65x303x140	SXBINSB6
8" (203mm) wide Cassette Bin	2	2 ⁹ / ₁₆ x11 ¹⁵ / ₁₆ x8	65x303x203	SXBINSB8

Note: Bins are shipped with one ID card.

Description	Cat. No.
Bin Accessories	
Cassette Bin Divider Kit (20 dividers)	SXBINDIV
Cassette Label Kit (includes label strips in Mauve, Slate Blue and Jade for identification of bins)	SXCASLAB
Cassette Bin Labels (5 sheets of Slate Blue bin labels — 18 of each size per sheet)	SXBINLAB-BL
Cassette Bin Labels (5 sheets of Jade bin labels — 18 of each size per sheet)	SXBINLAB-GR
Cassette Bin Labels (5 sheets of Mauve bin labels — 18 of each size per sheet)	SXBINLAB-RD

SXBINDIV divides up to 4 bins.

SXCASLAB includes 3 sheets of labels. One sheet per color. Each sheet contains 18 labels for each size bin. It also includes 18 patient ID bin cards for each size bin and 4 cassette ID labels.

Medication Cassette Transfer Carts

Description	Overall Dimensions		Inside Height (in.)	Approx. Pkd. Wt. (lbs.)	Approx. Pkd. Wt. (kg)	Cat. No.
	Height/Width/Length (in.)	Height/Width/Length (mm)				
Single-Wide, Double-Sided*						
40" (1016mm) Single	39 ³ / ₄ x24 ⁷ / ₈ x22 ¹ / ₁₆	1010x632x576	30 ¹ / ₄	768	150 68	SXS40TRAN
43" (1092mm) Single	42 ³ / ₄ x24 ⁷ / ₈ x22 ¹ / ₁₆	1086x632x576	33 ¹ / ₄	845	150 68	SXS43TRAN
46" (1168mm) Single	45 ³ / ₄ x24 ⁷ / ₈ x22 ¹ / ₁₆	1162x632x576	36 ¹ / ₄	921	157 71	SXS46TRAN
Double-Wide, Double Sided*						
40" (1016mm) Double	39 ³ / ₄ x24 ⁷ / ₈ x42 ¹ / ₂	1010x632x1080	30 ¹ / ₄	768	170 77	SXD40TRAN
43" (1092mm) Double	42 ³ / ₄ x24 ⁷ / ₈ x42 ¹ / ₂	1086x632x1080	33 ¹ / ₄	845	176 80	SXD43TRAN
46" (1168mm) Double	45 ³ / ₄ x24 ⁷ / ₈ x42 ¹ / ₂	1162x632x1080	36 ¹ / ₄	921	181 82	SXD46TRAN

*Cassette storage available on both front and back of cart.



Call today!

1.800.992.1776

*A customer service representative is
standing by to assist you.*

*Not in the USA? Look on the back cover
of your catalog for the contact information you need.*



We put space to work.™



Basix

BASIX™ OVERVIEW

BASIX PLUS

BASIX



Basix Plus – all the basics plus lighter, cleaner, easier.

CLEANER

Infection control: Cleanliness is improved by removing unsightly accessory holes found in traditional metal carts.

LIGHTER

Lightweight aluminum drawers and polymer components make Basix Plus lighter and easier to move than typical all-steel carts.

EASIER

Ergonomic push handles molded into the cart top minimize the cart's footprint and provide a natural location for maneuvering the cart. Side mounting channels allow for easy and flexible accessorization.

A color code must be included with each cart/drawer ordered. The color code determines the color of the drawer and on solid carts the color of the cart. The quantity should equal the total number of carts.



Cat. No. MB-BG Blue Gray	Cat. No. MB-CB Crash Cart Blue	Cat. No. MB-CR Cranberry	Cat. No. MB-DB Dark Blue	Cat. No. MB-DT Dark Taupe	Cat. No. MB-HG Hunter Green	Cat. No. MB-LA Lavender	Cat. No. MB-LT Light Taupe	Cat. No. MB-MA Mauve	Cat. No. MB-RE Red	Cat. No. MB-SB Slate Blue	Cat. No. MB-SG Sea Foam Green	Cat. No. MB-TE Teal	Cat. No. MB-YE Yellow
---------------------------------------	--	---------------------------------------	---------------------------------------	--	---	--------------------------------------	--	-----------------------------------	---------------------------------	--	---	----------------------------------	------------------------------------

Traditional materials. Inspired design.

DRAWER COLORS



- A. Touchpad and proximity reader feature auto re-lock and tamper-resistant programming.
- B. Pass thru shelf can be accessed from either side of the cart to maximize functionality.
- C. Self-closing ball bearing slides allow for smooth action of drawers to provide complete access to contents.
- D. Accessories including overbridge, extendible I.V. pole, and side storage allow supplies to be organized and easily accessible.
- E. Ergonomic polymer work surface has molded in handles to minimize cart footprint as well as a raised perimeter for spill containment .
- F. Polymer corner accessory channels improve cleanliness by eliminating dirt catching holes on sides and back of typical metal carts.
- G. Lightweight, full extension aluminum drawers make Plus lighter than all steel carts.
- H. Double-wall steel body with powder coated finish provides structural integrity.
- I. Polymer base reduces weight of cart and provides impact protection to cart and surroundings.



Cart packages include cart and accessories shown.

Code Response Cart
MBP3210CRT1
 with MBP410
 (Color Shown: MB-RE)



Accessory Package
MBPCR-1

Code Response Cart
MBP3210CRT2
 with MBP410
 (Color Shown: MB-RE)



Accessory Package
MBPCR-2

Pediatric Response Cart
MBP8100PEDS
 with MBA235
 (Shown with
 optional lock bars.)
 (Color Shown: MB-PEDS)



Accessory Package
MBPCRPEDS

Anesthesia Cart
MBP3210ANES1
 (Color Shown: MB-CR)



Accessory Package
MBPANES-1

Anesthesia Cart
MBP3210ANES2
 (Color Shown: MB-LT)



Accessory Package
MBPANES-2

Isolation Cart
MBP0120ISO

(Color Shown: MB-YE)



Accessory Package
MBPISO-1

Endoscopic Cart
MBP0120ENDO
 (Color Shown: MB-BG)



Accessory Package
MBPENDO-1

Trauma Cart
MBP3210TRAUMA
 with MBP410 Lock Bar
 (Color Shown: MB-MA)



Accessory Package
MBPED-1H

General Cart
MBP1210GEN
 (Color Shown: MB-DT)



Accessory Package
MBPBAS-1

Accessory Packages

Cat. No./ Description	Backboard	Counter Deth. Shelf	I.V. Pole	Plastic Seals	O ₂ Tank Brackets	Side Accy. Bracket (2)	Waste Container	Suction Unit Shelf	3" (76mm) Tray with Dividers	Side Shelf	Cart Top Rail	Overbridge Shelf	Hanger Rail	Divided Organizer	Outlet Strips	Label Holders	4 Tilt Bins	5 Tilt Bins	6 Tilt Bins	Callmeter Holder	Wire Basket	Glove Box Holder	Sharps Bracket	Coat Rack	Scope Holder (4)	Stable Bins (3)
MBPCR-1 Code Response Pkg. #1	1	1	1	1	1	1	1	1	1																	
MBPCR-2 Code Response Pkg. #2	1		1	1						1	1															
MBPCR-3 Code Response Pkg. #3	1		1	1	1	1		1				1-D	1		1	1										
MBPANES-1 Anesthesia Package #1			1			1	1				1		3*				1	1	1-28"	1						
MBPANES-2 Anesthesia Package #2			1			1	1			1	1	1-N	1									1	1			
MBPISO-1 Isolation Package #1						1																1		1		
MBPENDO-1 Endoscopic Package #1						1				1	1	2-N		1											1	
MBPED-1H Trauma Package #1			1			1						1-N	2		1		1		1			1	1			1
MBPBAS-1 Basic Package #1			1			1	1			1												1	1			
MBPCRPDS Pediatrics Package		1	1			1		1																		

*Includes 1 rail with hooks.

Basic Carts — 24¹/₈" W. x 30" L. (613x762mm)

Low Profile — 38¹/₂" (978mm) High

Drawer Space	Drawer Configuration	Color	Lock	Approx. Pkd. Wt. (lbs.) (kg)		Cat. No.
24" (610mm)	3 - 3" (76mm) 1 - 6" (152mm) 1 - 9" (230mm)	Two Tone	None	151	72	MBP3110TN*
24" (610mm)	1 - 3" (76mm) 2 - 6" (152mm) 1 - 9" (230mm)	Two Tone	None	151	72	MBP1210TN
24" (610mm)	3 - 3" (76mm) 1 - 6" (152mm) 1 - 9" (230mm)	Two Tone	Breakaway Lock Bar	151	72	MBP3110TB*
24" (610mm)	3 - 3" (76mm) 1 - 6" (152mm) 1 - 9" (230mm)	Two Tone	Key Lock	151	72	MBP3110TL*
24" (610mm)	1 - 3" (76mm) 2 - 6" (152mm) 1 - 9" (230mm)	Two Tone	Key Lock	151	72	MBP1210TL
24" (610mm)	1 - 6" (152mm) 2 - 9" (230mm)	Two Tone	Key Lock	151	72	MBP0120TL

*Also available in solid colors

Cart: MBP0120TL
Color: MB-YE (Yellow)
Two-Tone
(shown with accessories)



Note:

Two Tone carts have a light taupe cart body and a specified drawer color.

Solid carts have one solid color, where the cart body matches the specified drawer color.



Pass Thru Side Shelf
Cat. No. **MBP300**



Touchpad with Proximity Reader
May be ordered with key locking carts only.
Cat. No. **MBP445**



Pushbutton Lock
May be ordered with key locking carts only.
Cat. No. **MBA435**

Basic Carts - 24¹/₈" (613mm)H x 30" (672mm)L
High Profile — 45" (1440mm) High

Drawer Space	Drawer Configuration	Color	Lock	Approx. Pkd. Wt. (lbs.) (kg)		Cat. No.
30" (762mm)	4 - 3" (76mm)	Two Tone	None	159	75	MBP4101TN*
	1 - 6" (152mm)					
	1 - 12" (304mm)					
30" (762mm)	3 - 3" (76mm)	Two Tone	None	159	75	MBP3210TN*
	2 - 6" (152mm)					
	1 - 9" (230mm)					
30" (762mm)	4 - 3" (76mm)	Two Tone	Breakaway Lock Bar	159	75	MBP4101TB*
	1 - 6" (152mm)					
	1 - 12" (304mm)					
30" (762mm)	4 - 3" (76mm)	Two Tone	Key Lock	159	75	MBP4101TL*
	1 - 6" (152mm)					
	1 - 12" (304mm)					
30" (762mm)	3 - 3" (76mm)	Two Tone	Key Lock	159	75	MBP3210TL
	2 - 6" (152mm)					
	1 - 9" (230mm)					

Note: Drawer color and solid cart body color is specified by ordering the desired color/code from page 32.

*Also available in solid colors

Build-A-Cart
Cart Body

Low Profile — 38¹/₂" (978mm) High

Drawer Space	Drawer Configuration	Color	Lock	Width (in.) (mm)		Length (in.) (mm)		Cat. No.
24" (610mm)	Empty	Two Tone	None	24 ¹ / ₈	613	30	762	MBP24TN*
24" (610mm)	Empty	Two Tone	Breakaway Lock Bar	24 ¹ / ₈	613	30	762	MBP24TB*
24" (610mm)	Empty	Two Tone	Key Lock	24 ¹ / ₈	613	30	762	MBP24TL*

High Profile — 45" (1143mm) High

Drawer Space	Drawer Configuration	Color	Lock	Width (in.) (mm)		Length (in.) (mm)		Cat. No.
30" (762mm)	Empty	Two Tone	None	24 ¹ / ₈	613	30	762	MBP30TN*
30" (762mm)	Empty	Two Tone	Breakaway Lock Bar	24 ¹ / ₈	613	30	762	MBP30TB*
30" (762mm)	Empty	Two Tone	Key Lock	24 ¹ / ₈	613	30	762	MBP30TL*

*Also available in solid colors

Drawers

Description	Wt. Capacity (lbs.) (kg)		Width (in.) (mm)		Length (in.) (mm)		Height (in.) (mm)		Cat. No.
3" (76mm) Deep Aluminum Drawer	50	24	17	432	22 ¹ / ₄	565	2 ⁷ / ₈	73	MBP103
6" (152mm) Deep Aluminum Drawer	50	24	17	432	22 ¹ / ₄	565	6 ¹ / ₄	159	MBP106
9" (230mm) Deep Aluminum Drawer	50	24	17	432	22 ¹ / ₄	565	9 ³ / ₈	238	MBP109
12" (51mm) Deep Aluminum Drawer	50	24	17	432	22 ¹ / ₄	565	12 ¹ / ₄	311	MBP112

Note: Drawer color and solid cart body color is specified by ordering the desired color/code from page 32.

Accessories (Cart Mounted)

Description	Dimensions Height/Width/Length (in.) (mm)		Approx. Pkd. Wt. (lbs.) (kg)		Cat. No.
Pass Thru Side Shelf	-	-	-	-	MBP300[†]
Plastic Seals (100 per Package)	-	-	1	.455	MBA400
Breakaway Lock Bar	3	76	1	.455	MBP401
Breakaway Lock Bar	6	152	1	.455	MBP402
Breakaway Lock Bar	9	230	1	.455	MBP403
Breakaway Lock Bar	12	205	1	.455	MBP404
Breakaway Lock Bar	18	203	2	.90	MBP406
Breakaway Lock Bar	21	533	3	1.36	MBP407
Breakaway Lock Bar	24	610	3	1.36	MBP408
Breakaway Lock Bar	27	686	3	1.36	MBP409
Breakaway Lock Bar	30	762	3	1.36	MBP410
Key Lock Bar	3	76	1	.455	MBP421
Key Lock Bar	6	152	1	.455	MBP422
Mechanical Push Button Lock	-	-	-	-	MBP435
Electronic Touch Pad	-	-	-	-	MBP440
Proximity Reader/Electronic Touch Pad	-	-	-	-	MBP445
Retro-Fit Proximity Reader	-	-	-	-	MBP450
Cardiac Board with Brackets	15 ¹ / ₂ x 3 ³ / ₄ x 21 ¹ / ₂	394x20x546	4	1.82	MBP600
Corner Defibrillator Shelf	9 ¹ / ₂ x 12 x 13	241x305x330	11	5.00	MBP602*
Suction Unit Shelf	10 x 7 ³ / ₄ x 19	254x197x482	2	.91	MBA605
Cart Top Rail	5 x 17 ³ / ₄ x 28 ¹ / ₂	127x451x724	4	1.82	MBP610
Coat Rack	1 x 3	25x76	3	1.36	MBA664
I.V. Pole	47 ¹ / ₂ H. x 9 ¹ / ₂ W.	1207x241	4	1.82	MBA667
Hospital Grade Outlet Strip			4	1.82	MBA696
6 Outlets, 15' (4572mm) Cord					

*Swivels 360 degrees, 75 lbs. (35kg) weight capacity. Adjusts from 13" (330mm) L. to 18" (457mm) L.
[†] 25lb. Weight Capacity



MBA605



MBA664

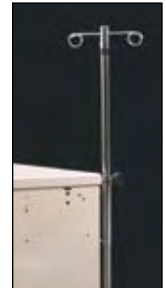

MBA667



MBA696



MBP410



MBP602



MBP610



MBA113

Drawer Accessories

Description	Dimensions Height/Width/Length (in.) (mm)		Approx. Pkd. Wt. (lbs.) (kg)		Cat. No.
3" (76mm) Flexible Drawer Divider Kit			1	.455	MBA113
4 Perimeter Rails, 2 Long Dividers, 6 Short Dividers					
Additional Short Divider (1 pc.) for MBA113					MBA114
Additional Long Divider (1 pc.) for MBA113					MBA115
6/9" (152/230mm) Flexible Drawer Divider Kit			1	.455	MBA116
4 Perimeter Rails, 2 Long Dividers, 6 Short Dividers					
Additional Short Divider (1 pc.) for MBA116					MBA117
Additional Long Divider (1 pc.) for MBA116					MBA118
Additional Divider Clips (left) for MBA117					MBA119
Additional Divider Clips (right) for MBA117					MBA120
3" (76mm) Drawer Fixed Divider Kit			2	.91	MBA123
2 - 22" (559mm) Rails, 6 Front-to-Back Dividers					
6" (152mm) Drawer Fixed Divider Kit			2	.91	MBA126
2 - 22" (559mm) Rails, 6 Front-to-Back Dividers					
9" (230mm) Drawer Fixed Divider Kit			3	1.36	MBA129
2 - 22" (559mm) Rails, 6 Front-to-Back Dividers					
3" (76mm) Narrow Expandable Tray	2x3 ¹ / ₄ x 9-15	53x83x229-381			MBA148
3" (76mm) Wide Expandable Tray	2x6x 9-15	53x152x229-381			MBA149
3" (76mm) Tray — No Dividers	2 ¹ / ₄ x 15 ¹ / ₄ x 21 ¹ / ₂	57x387x546	4	1.82	MBA150
3" (76mm) Tray with 2 Long and 6 Short Dividers	2 ¹ / ₄ x 15 ¹ / ₄ x 21 ¹ / ₂	57x387x546	5	2.27	MBA151
3" (76mm) Tray with 2 Long 8 Short and 14 Ampule Dividers	2 ¹ / ₄ x 15 ¹ / ₄ x 21 ¹ / ₂	57x387x546	5	2.27	MBA152
3" (76mm) Tray, 2 Long, 7 Short, and 18 Ampule Dividers	2 ¹ / ₄ x 15 ¹ / ₄ x 21 ¹ / ₂	57x387x546	5	2.27	MBA153
3" (76mm) Tray, 33 Ampule Dividers with Lid	2 ¹ / ₄ x 15 ¹ / ₄ x 21 ¹ / ₂	57x387x546	8	3.64	MBA154
3" (76mm) Tray, 33 Ampule Dividers — No Lid	2 ¹ / ₄ x 15 ¹ / ₄ x 21 ¹ / ₂	57x387x546	6	2.73	MBA155
Clear Lid for MBA150 thru MBA155 and MBA159			2	.91	MBA158
6" (152mm) Tray with 2 Long, 6 Short Dividers	5x15 ¹ / ₄ x 21 ¹ / ₂	127x387x546	7	3.18	MBA159



MBA126



MBA152



MBA151



MBA159

Drawer Accessories (Continued)

Description	Dimensions		Approx.		Cat. No.
	(in.)	Height/Width/Length (mm)	Pkd. Wt. (lbs.)	(kg)	
Full Drawer Tray with Lid	2 ³ / ₄ x16x 22	70x406x559	4	1.82	MBA160
Divider Set for MBA160	2 - 20 ⁵ / ₈ " (524mm), 4 - 14" (356mm), 6 - 5 ¹ / ₂ " (140mm)		2	.91	MBA161
3" (76mm) Drawer Tote, Maximum 2 per Drawer	2 ³ / ₄ x16 ¹ / ₂ x10 ⁷ / ₈	70x419x276	1	.455	MBA162
Long Divider for MBA162, 11 Maximum per Tote			.38	.173	MBA163
Short Divider for MBA162, 7 Maximum per Tote			.3	.136	MBA164
5" (127mm) Drawer Tote, Maximum 2 per Drawer	6x16 ¹ / ₂ x10 ⁷ / ₈	152x419x276	2	.92	MBA165
Long Divider for MBA165, 11 Maximum per Tote			.75	.341	MBA166
Short Divider for MBA165, 7 Maximum per Tote			.5	.227	MBA167
Label Holders with Blanks (100 per Package)	3L.x1H.	76x25	1	.455	MBA170
Label Holders with Blanks (100 per Package)	7L.x2H.	178x51	2	.92	MBA171
Label Holders (12 per Package)	7L.x2H.	178x51	.2	.091	MBA172
Security Bags for 3" (76mm) Tray (20 per Package) — Fits MBA150-MBA155			1	.455	MBA183
Security Bags for 5" (127mm) Tray (20 per Package) — Fits MBA159			1	.455	MBA185
Lockable Drawer Cover			5	2.27	MBA190
Security Box	2 ⁵ / ₈ x16x11	67x406x279	7	3.18	MBA193
Punch Card Security Box	9x16x7	229x406x167	5	2.27	MBA199



Cart: MBP0120TL
Color: MB-BG
(shown with optional accessories)



MBA116

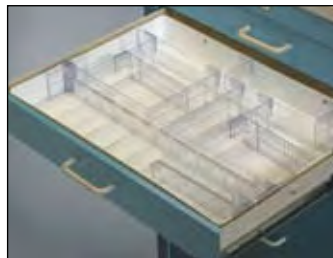

MBA153



(2) MBA162 with Dividers



* Long dividers are available in natural color only.



MBA129



MBA183



MBA123

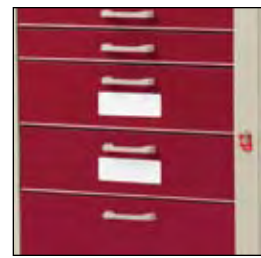

MBA171-MBA172

A color code must be included with each cart/drawer ordered. The color code determines the color of the drawer and on solid carts the color of the cart. The quantity should equal the total number of carts.



Cat. No. MB-BG Blue Gray	Cat. No. MB-CB Crash Cart Blue	Cat. No. MB-CR Cranberry	Cat. No. MB-DB Dark Blue	Cat. No. MB-DT Dark Taupe	Cat. No. MB-HG Hunter Green	Cat. No. MB-LA Lavender	Cat. No. MB-LT Light Taupe	Cat. No. MB-MA Mauve	Cat. No. MB-RE Red	Cat. No. MB-SB Slate Blue	Cat. No. MB-SG Sea Foam Green	Cat. No. MB-TE Teal	Cat. No. MB-YE Yellow
------------------------------------	--	------------------------------------	------------------------------------	-------------------------------------	---------------------------------------	-----------------------------------	--------------------------------------	--------------------------------	------------------------------	-------------------------------------	---	-------------------------------	---------------------------------

Side Accessories

Description	Dimensions		Approx.		Cat. No.
	Height/Width/Length (in.)	(mm)	Pkd. Wt. (lbs.)	(kg)	
Side Accessory Bracket (2 Pack)	4x18x1/4	102x457x6	1	.455	MBP205
Back Accessory Bracket (2 Pack)	4x261/4	102x643	2	.91	MBP207
Side Storage Unit 30"H. (762mm) with 3 Shelves	343/8x18x131/2	886x457x342	52	23.7	MBA200
Push Handles (Pair)	-	-	1	.455	MBP209
3 Wide Glove Box Holder	163/4x33/4x10	426x95x254	-	-	MBA214
Glove Box Holder	10x33/4x53/4	254x95x146	2	.91	MBA215*
3 Side Bins	Each Bin: 4x41/2x183/8	102x114x254	13	5.9	MBP216
Wire Basket	13x31/2x10	330x89x254	1	.455	MBA218*
Waste Container with Lift Top (20 Quart)	18x14x10	457x356x254	3	1.37	MBA220*
Waste Container — No Top (28 Quart)	151/4x143/8x101/4	387x365x260	3	1.37	MBA221*
Side Shelf — 25 lb. (11kg) Capacity	147/8L.x173/4W.	378L.x451W.	8	3.6	MBP230
Oxygen Tank Brackets	7L.x7W.	178L.x178W.	2	.91	MBA235*
Catheter Holder, Short 19" (482mm)	19x4x8	482x102x203	8	3.64	MBA241*
Catheter Holder, Short 19" (482mm) — Clear Front	19x4x4	482x102x102	8	3.64	MBA242*
Catheter Holder, Long 28" (711mm)	28x4x8	711x102x203	8	3.64	MBA243*
Catheter Holder, Long 28" (711mm) — Clear Front	28x4x4	711x102x102	8	3.64	MBA244*
Scope Holder, 2	48x6x9	1219x152x229	22	10.01	MBA245*
Scope Holder, 4	48x6x16	1219x152x406	34	15.47	MBA246*
Sharps Bracket (Adjustable)	9x18x51/4	616x330x140	1	.455	MBP250*
Lockable Sharps Container	241/4x13x51/2	105x133x203	4	1.82	MBA251*
Hospital Grade Outlet Strip	41/8x51/4x8	105x133x203	4	1.82	MBA696
Outlets, 15' (4572mm) Cord					

*Mount to MBP205 or MBP207.

**25lbs. (12kg) weight capacity.



MBP205, MBP235, MBA696



MBP209



MBA215



MBA221

Overbridge & Accessories

Description	Dimensions		Approx.		Cat. No.
	Height/Width/Length (in.)	(mm)	Pkd. Wt. (lbs.)	(kg)	
Wire Basket	13x31/2x10	330x89x254	1	.455	MBA218*
Tape Dispenser/Counter Top Model	4x4x11	102x102x279	5	2.27	MBA580
Tape Dispenser with 2 Brackets for Overbridge	4x4x11	102x102x279	6	2.73	MBA583
Divided Organizer with Lid and Brackets	21/4x71/8x71/8	57x181x181	2	.91	MBA586
Overbridge, 1 Shelf — Narrow	20x10x27	508x254x686	10	4.55	MBP505
Overbridge, 2 Shelf — Narrow	20x10x27	508x254x686	13	5.91	MBP506
Overbridge, 3 Hanger Rails	20x1x26	508x25x686	7	3.18	MBP511
Overbridge, 3 Hanger Rails, 1 with Hooks	21x8x26	533x203x660	7	3.18	MBP512
Overbridge, 1 Shelf — Deep	21x141/2x27	533x368x686	11	5.00	MBP515
Overbridge, 2 Shelf — Deep	21x141/2x27	533x368x686	14	6.37	MBP520
Tilt Bin 3 Units	91/2x73/4x221/2	241x197x571	7	3.18	MBP543††
Tilt Bin 4 Units	81/8x61/2x221/2	206x165x571	6	2.73	MBP544††
Tilt Bin 5 Units	61/2x51/4x221/2	165x133x571	4	.455	MBP545††
Tilt Bin 6 Units	41/2x51/4x221/2	114x133x571	3	.76	MBP546††
Hanger Rail	1x26	25x660	2	.91	MBP550
Hanger Rail with Hooks	3x26	76x660	2	.91	MBP551

*75 lbs. (35kg) weight capacity.

†Shelf swivels 360 degrees.

††Mounts to overbridge rail (ordered separately).



MBP505, MBP546, MBP544



MBP512, MBP545, MBP546



MBP216



MBP230



MBA241



MBA244



MBA245



MBA246



Cart: MBPC3110TL
Color: MBC-YE
(shown with accessories)



Cart: MBPC3210TL
Color: MBC-LT
(shown with accessories)



Cart: MBP8100TN
Color: MB-PEDS

NEW BASIX PLUS COMPACT CARTS

Basic Carts — 22¹/₂" (572mm)W x 24¹/₄" (610mm)L

Low Profile — 38" (965mm) High

Drawer Space	Drawer Configuration	Color	Lock	Approx. Pkd. Wt. (lbs.) (kg)		Cat. No.
24" (610mm)	3 - 3" (76mm)	Two Tone	Key Lock	133	61	MBPC3110TL
	1 - 6" (152mm)					
	1 - 9" (230mm)					
24" (610mm)	1 - 3" (76mm)	Two Tone	Key Lock	133	61	MBPC1210TL
	2 - 6" (152mm)					
	1 - 9" (230mm)					

High Profile — 44" (1118mm) High

Drawer Space	Drawer Configuration	Color	Lock	Approx. Pkd. Wt. (lbs.) (kg)		Cat. No.
30" (762mm)	3 - 3" (76mm)	Two Tone	Key Lock	140	64	MBPC3210TL
	2 - 6" (152mm)					
	1 - 9" (230mm)					

*Note: Drawer color and solid cart body color is specified by ordering the desired color/code on page 47.

Build-A-Cart

Cart Body

Low Profile — 37¹/₂" (953mm) High

Drawer Space	Drawer Configuration	Color	Lock	Width (in.) (mm)		Length (in.) (mm)		Cat. No.
24" (610mm)	Empty	Two Tone	Key Lock	22 ¹ / ₂	572	24	610	MBPC24TL

High Profile — 43¹/₈" (1095mm) High

Drawer Space	Drawer Configuration	Color	Lock	Width (in.) (mm)		Length (in.) (mm)		Cat. No.
30" (762mm)	Empty	Two Tone	Key Lock	22 ¹ / ₂	572	24	610	MBPC30TL

Drawers

Description	Wt. Capacity (lbs.) (kg)	Width (in.) (mm)	Length (in.) (mm)	Height (in.) (mm)	Cat. No.
3" (76mm) Deep Aluminum Drawer	50 24	17 432	22 ¹ / ₄ 565	2 ⁷ / ₈ 73	MBPC103
6" (152mm) Deep Aluminum Drawer	50 24	17 432	22 ¹ / ₄ 565	6 ¹ / ₄ 159	MBPC106
9" (230mm) Deep Aluminum Drawer	50 24	17 432	22 ¹ / ₄ 565	9 ³ / ₈ 238	MBPC109

*Note: Drawer color and solid cart body color is specified by ordering the desired color/code on page 47.

Accessories

Description	Width (in.) (mm)	Length (in.) (mm)	Height (in.) (mm)	Wt. Capacity (lbs.) (kg)		Cat. No.
Cart Top Rail				4	1.82	MBPC210
Overbridge, 3 Hanger Rails				7	3.18	MBPC511

Note: Any divider kit from a Basix Compact cart will work on Basix Plus Compact. Any Basix Plus side accessory will work on Basix Plus Compact.

NEW BASIX PLUS PEDIATRICS CARTS

Pediatric Carts — 24¹/₈" W. x 30" L. (613x762mm)

45" (1143mm) High

Drawer Space	Drawer Configuration	Color	Lock	Approx. Pkd. Wt. (lbs.) (kg)		Cat. No.
30" (762mm)	8 - 3" (76mm)	Two Tone	Non Lock	151	72	MBP8100TN
	1 - 6" (152mm)					
30" (762mm)	8 - 3" (76mm)	Two Tone	Breakaway Lock	151	72	MBP8100TB
	1 - 6" (152mm)					

Note: Drawer color MB-PEDS quantity should equal the total number of carts.

Feel Secure.

New electronic locking feature. It's security you can rely on.

Add Electronic Locking to any Basix Plus Cart

Description	Cat. No
Electronic Touch Pad	MBP440
Proximity Reader/Electronic Touch Pad	MBP445
Retro-Fit Proximity Reader	MBP450
Proximity Card	MBP441
Proximity Sticker	MBP442
Proximity Key Fob	MBP443



New Pass Thru Side Shelf. More work space where you need it.

Add Pass Thru Side Shelf to any Basix Plus Cart

Description	Cat. No
Pass Thru Side Shelf	MBP300



New Look.

Coming in 2009...
A Fresh New look for Basix.

NEW CONTEMPORARY COLORS



BASIX PROCEDURE CARTS

Cart packages include cart & accessories shown..

Code Response Cart
MBX4101CRT1
(Color Shown: MB-CB)



Accessory Package
MBXCR-1

Code Response Cart
MBX3210CRT2
(Color Shown: MB-RE)



Accessory Package
MBXCR-2

Code Response Cart
MBX3210CRT3
(Color Shown: MB-RE)



Accessory Package
MBXCR-3

Anesthesia Cart
MBX3210ANES3
(Color Shown: MB-SB)



Accessory Package
MBXANES-1

Anesthesia Cart
MBX1310ANES4
(Color Shown: MB-SB)



Accessory Package
MBXANES-2

Isolation Cart
MBX3110ISO
(Color Shown: MB-YE)



Accessory Package
MBXISO-1

Endoscopic Cart
MBX3110ENDO
(Color Shown: MB-MA)



Accessory Package
MBXENDO-1

Trauma Cart
MBX3210TRAUMA
(Color Shown: MB-HG)



Accessory Package
MBXED-1H

General Cart
MBX1310GEN
(Color Shown: MB-SB)



Accessory Package
MBXBAS-1

Accessory Packages

Cat. No./ Description	Backboard	Corner Defib. Shelf	I.V. Pole	Plastic Seals	O ₂ Tank Brackets	Side Acyl. Bracket	Waste Container	Suction Unit Shelf	3" (76mm) Tray with Dividers	Side Shelf	Cart Top Rail	Overbridge Shelf	Overbridge Hanger Rail	Divided Organizer	Outlet Strip	Label Holders	4 Tilt Bins	5 Tilt Bins	6 Tilt Bins	Glove Box Holders	Sharps Bracket	Coat Rack	Scope Holder (4)	Side Bins (3)	Push Handles (2)	Pushbutton Lock
MBXCR-1 Code Response Pkg. #1	1	1	1	1	1			1	1	1					1										1	
MBXCR-2 Code Response Pkg. #2	1		1	1							1										1				1	
MBXCR-3 Code Response Pkg. #3	1		1	1				1				1*	2			1									1	
MBXANES-1 Anesthesia Package #1			1				1	1		1	1		3**				1	1							1	1
MBXANES-2 Anesthesia Package #2			1				1	1		1		1	1					1		1	1					1
MBXISO-1 Isolation Package #1											1									1		1				
MBXENDO-1 Endoscopic Package #1			1							1		2	2	1										1		
MBXED-1H Trauma Package #1			1									1	1		1		1			1	1			1	1	
MBXBAS-1 General Package #1			1				1	1		1										1	1					

*Swivel shelf.
**One with hooks

Basic Carts

24¹/₈" W. x 30" L. (613 x 762mm)

Low Profile — 38¹/₂" (978mm) High

Drawer Space	Drawer Configuration	Color	Lock	Approx. Pkd. Wt. (lbs.) (kg)	Cat. No.
24" (610mm)	3 - 3" (76mm)	Two Tone	Breakaway Lock Bar	151 72	MBX3110TB
	1 - 6" (152mm)				
	1 - 9" (230mm)				
24" (610mm)	3 - 3" (76mm)	Two Tone	Key Lock	151 72	MBX3110TL
	1 - 6" (152mm)				
	1 - 9" (230mm)				
24" (610mm)	1 - 3" (76mm)	Two Tone	Key Lock	151 72	MBX1210TL
	2 - 6" (152mm)				
	1 - 9" (230mm)				

*Also available in solid body color.



Cart: MBX3210TB
Color: MB-RE
(Shown with optional accessories)

Note:

Two Tone carts have a light taupe cart body and a specified drawer color.

Solid carts have one solid color, where the cart body matches the specified drawer color.



Cart: MBX8100TB
Color: MB-PEDS



Pushbutton Lock
May be ordered with key locking carts only.
Cat. No. **MBA435**

Basic Carts
24¹/₈" W. x 30" L. (613 x 762mm)
High Profile — 45" (1440mm) High

Drawer Space	Drawer Configuration	Color	Lock	Approx. Pkd. Wt. (lbs.) (kg)		Cat. No.
30" (762mm)	4 - 3" (76mm) 1 - 6" (152mm) 1 - 12" (230mm)	Two Tone	Breakaway Lock Bar	159	75	MBX4101TB
30" (762mm)	3 - 3" (76mm) 2 - 6" (152mm) 1 - 9" (230mm)	Two Tone	Breakaway Lock Bar	159	75	MBX3210TB
30" (762mm)	4 - 3" (76mm) 1 - 6" (152mm) 1 - 12" (304mm)	Two Tone	Key Lock	159	75	MBX4101TL
30" (762mm)	3 - 3" (76mm) 2 - 6" (152mm) 1 - 9" (230mm)	Two Tone	Key Lock	159	75	MBX3210TL
30" (762mm)	2 - 3" (76mm) 2 - 6" (152mm) 1 - 12" (304mm)	Two Tone	Key Lock	159	75	MBX2201TL

Pediatric Code Response Cart
24¹/₈" W. x 30" L. (613 x 762mm)

Drawer Space	Drawer Configuration	Color	Lock	Approx. Pkd. Wt. (lbs.) (kg)		Cat. No.*
30" (762mm)	8 - 3" (76mm) 1 - 6" (152mm)	Two Tone	Breakaway Lock Bar	133	63	MBX8100TB

Note: Drawer color MB-PEDS quantity should equal the total number of carts.

Build-A-Cart
Cart Body
Low Profile — 38¹/₂" (978mm) High

Drawer Space	Drawer Configuration	Color	Lock	Width (in.) (mm)		Length (in.) (mm)		Cat. No.
24" (610mm)	Empty	Two Tone	Breakaway Lock Bar	24 ¹ / ₈	613	30	762	MBX24TB
24" (610mm)	Empty	Two Tone	Key Lock	24 ¹ / ₈	613	30	762	MBX24TL

High Profile — 45" (1143mm) High

Drawer Space	Drawer Configuration	Color	Lock	Width (in.) (mm)		Length (in.) (mm)		Cat. No.
30" (762mm)	Empty	Two Tone	Breakaway Lock Bar	24 ¹ / ₈	613	30	762	MBX30TB
30" (762mm)	Empty	Two Tone	Key Lock	24 ¹ / ₈	613	30	762	MBX30TL

Note: Drawer color and solid cart body color is specified by ordering the desired color/code from page 37.

Drawers

Description	Wt. Capacity (lbs.) (kg)		Height (in.) (mm)		Depth (in.) (mm)		Length (in.) (mm)		Cat. No.
3" (76mm) Deep Steel Drawer	50	24	2 ⁷ / ₈	73	17	432	22 ¹ / ₄	565	MBX103
6" (152mm) Deep Steel Drawer	50	24	6 ¹ / ₄	159	17	432	22 ¹ / ₄	565	MBX106
9" (230mm) Deep Steel Drawer	50	24	9 ³ / ₈	238	17	432	22 ¹ / ₄	565	MBX109
12" (305mm) Deep Steel Drawer	50	24	12 ¹ / ₄	311	17	432	22 ¹ / ₄	565	MBX112

Accessories (Cart Mounted)

Description	Dimensions Height/Width/Length (in.)	Dimensions Height/Width/Length (mm)	Approx. (lbs.)	Pkd. Wt. (kg)	Cat. No.
Plastic Seals (100 per Package)			1	.455	MBA400
Mechanical Push Button Lock			1	.455	MBA435
Cardiac Board with Brackets	15 1/2 H.x21 1/2 L.x3 3/4 W.	394H.x546L.x20W	4	1.82	MBX600
Corner Defibrillator Shelf			11	5.00	MBX602
Suction Unit Shelf	10H.x19L.x73/4W.	254x482x197	2	.91	MBA605
Cart Top Rail	5x17 3/4 x28 1/2	127x451x724	4	1.82	MBX610
Overbridge, 1 Swivel Shelf, 2 Hanger Rails	14W.x27L.	356x386	26	11.83	MBX615*
Overbridge, 2 Shelf (1 Swivel), 2 Hanger Rails	14W.x27L.	356x386	30	13.65	MBX620*
Coat Rack			3	1.36	MBA664
I.V. Pole			4	1.82	MBA667
Hospital Grade Outlet Strip — 6 Outlets, 15' (4572mm) Cord			4	1.82	MBA696

*Swivels 360 degrees, 75 lbs. (35kg) weight capacity.



MBX600



MBX602



MBA605



MBX610



MBX615



MBA113

Drawer Accessories

Description	Dimensions Height/Width/Length (in.)	Dimensions Height/Width/Length (mm)	Approx. (lbs.)	Pkd. Wt. (kg)	Cat. No.
3" (76mm) Flexible Drawer Divider Kit			1	.455	MBA113
4 Perimeter Rails, 2 Long Dividers, 6 Short Dividers					
Additional Short Divider (1 pc.) for MBA113					MBA114
Additional Long Divider (1 pc.) for MBA113					MBA115
6/9" (152/230mm) Flexible Drawer Divider Kit			1	.455	MBA116
4 Perimeter Rails, 2 Long Dividers, 6 Short Dividers					
Additional Short Divider (1 pc.) for MBA116					MBA117
Additional Long Divider (1 pc.) for MBA116					MBA118
3" (76mm) Drawer Fixed Divider Kit 2 - 22" (559mm) Rails, 6 Front-to-Back Dividers			2	.91	MBA123
6" (152mm) Drawer Fixed Divider Kit 2 - 22" (559mm) Rails, 6 Front-to-Back Dividers			2	.91	MBA126
9" (230mm) Drawer Fixed Divider Kit 2 - 22" (559mm) Rails, 6 Front-to-Back Dividers			3	1.36	MBA129
3" (76mm) Tray — No Dividers	2 1/4 x15 1/4 x 21 1/2	57x387x546	4	1.82	MBA150
3" (76mm) Tray with 2 Long and 6 Short Dividers	2 1/4 x15 1/4 x 21 1/2	57x387x546	5	2.27	MBA151
3" (76mm) Tray with 2 Long 8 Short and 14 Ampule Dividers	2 1/4 x15 1/4 x 21 1/2	57x387x546	5	2.27	MBA152
3" (76mm) Tray, 2 Long, 7 Short, and 18 Ampule Dividers	2 1/4 x15 1/4 x 21 1/2	57x387x546	5	2.27	MBA153
3" (76mm) Tray, 33 Ampule Dividers with Lid	2 1/4 x15 1/4 x 21 1/2	57x387x546	8	3.64	MBA154
3" (76mm) Tray, 33 Ampule Dividers — No Lid	2 1/4 x15 1/4 x 21 1/2	57x387x546	6	2.73	MBA155
Clear Lid for MBA150 thru MBA155 and MBA159			2	.91	MBA158
6" (152mm) Tray with 2 Long, 6 Short Dividers	5x15 1/2 x21 1/2	127x387x546	7	3.18	MBA159
Full Drawer Tray with Lid	2 3/4 x16x22	70x406x559	4	1.82	MBA160
Divider Set for MBA160			2	.91	MBA161
2 - 20 5/8" (524mm), 4 - 14" (356mm) 6 - 5 1/2" (140mm)					
3" (76mm) Drawer Tote, Maximum 2 per Drawer	2 3/4 x16 1/2 x10 7/8	70x419x276	1	.455	MBA162
Long Divider for MBA162, 11 Maximum per Tote			.38	.173	MBA163
Short Divider for MBA162, 7 Maximum per Tote			.3	.136	MBA164
5" (127mm) Drawer Tote	6x16 1/2 x10 7/8	152x419x276	2	.91	MBA165
Long Divider for MBA165, 11 Maximum per Tote			.75	.341	MBA166
Short Divider for MBA165, 7 Maximum per Tote			.5	.227	MBA167
Label Holders with Blanks (100 per Package)	3L.x1H.	76x25	1	.455	MBA170
Label Holders with Blanks (100 per Package)	7L.x2H.	178x51	2	.91	MBA171
Label Holders with Blanks (12 per Package)	7L.x2H.	178x51	.2	.091	MBA172
Security Bags for 3" (76mm) Tray (20 per Package) Fits MBA150-MBA155			1	.455	MBA183
Security Bags for 5" (127mm) Tray (20 per Package) Fits MBA159			1	.455	MBA185
Lockable Drawer Cover			7	3.18	MBA190
Security Box	2 5/8 x16x11	67x406x279	5	2.27	MBA193
Punch Card Security Box	9x16x7	229x406x178	5	2.27	MBA199



MBA151



MBA152



MBA159

MBA126



MBA221



MBA200



MBX207



MBX208



MBX209



MBA215, MBX250



MBA586

Side Accessories

Description	Dimensions		Approx. Pkd. Wt.		Cat. No.
	(in.)	Height/Width/Length (mm)	(lbs.)	(kg)	
Side Accessory Bracket	18W.x1	457W.x25	1	.455	MBX205*
Side Storage Unit 30" (762mm) H. with 3 Shelves	34 ³ / ₈ x18x13 ¹ / ₂		52	23.7	MBA200
Side Handle, Tubular	18W.	457W.	2	.91	MBX207
Utility Hooks (2 per Package)	2 ¹ / ₄ x1x1 ¹ / ₂	57x25x13	1	.455	MBX208
Pair Push Handles			1	.455	MBX209
Glove Box Holder	10x3 ³ / ₄ x5 ³ / ₄	254x95x146	2	.91	MBA215
3 Side Bins 24" (610mm) H each Bin	4x4 ¹ / ₂ x18 ³ / ₈	102x114x254	12	5.46	MBX216*
3 Side Bins 30" (762mm) H each Bin	4x4 ¹ / ₂ x18 ³ / ₈	102x114x254	12	5.46	MBX217*
Wire Basket	13x3 ¹ / ₂ x10	330x89x254	1	.455	MBA218*
Waste Container with Lift Top (20 Quart)	18x14x10	457x356x254	3	1.37	MBA220*
Waste Container — No Top (28 Quart)	15 ¹ / ₄ x14 ³ / ₈ x10 ¹ / ₄	387x365x260	3	1.37	MBA221*
Side Shelf	14 ⁷ / ₈ L.x17 ³ / ₄ W.	378L.x451W.	8	3.64	MBX230**
Oxygen Tank Brackets	7L.x7W.	178L.x178W.	2	.91	MBA235
Catheter Holder, Short 19" (482mm) W.	19x4x8	482x102x203	8	3.64	MBA241
Catheter Holder, Short 19" (482mm) W. — Clear Front	19x4x4	482x102x102	8	3.64	MBA242
Catheter Holder, Long 28" (711mm)	28x4x4	711x102x102	8	3.64	MBA243
Catheter Holder, Long 28" (711mm) — Clear Front	28x4x4	711x102x102	8	3.64	MBA244
Scope Holder, 2	48x6x16	1219x152x406	22	10.01	MBA245
Scope Holder, 4	48x6x16	1219x152x406	34	15.47	MBA246
Sharps Bracket			2	.91	MBX250
Hospital Grade Outlet Strip — 6 Outlets, 15' (4572mm) Cord			4	1.82	MBA696

*MBX205 required for side attachment of wire basket and waste baskets.
 **25lbs. (12kg) weight capacity.

Overbridge & Accessories

Description	Dimensions		Approx. Pkd. Wt.		Cat. No.
	(in.)	Height/Width/Length (mm)	(lbs.)	(kg)	
Overbridge, 3 Hanger Rails	22H.x27L.	559x686	6	2.73	MBX511
Overbridge, 3 Hanger Rails, 1 with Hook	22H.x27L.	559x686	6	2.73	MBX512
Overbridge with 1 Shelf, 1 Hanger Rail	14W.x27L.	356x686	10	4.55	MBX515*
Overbridge with 2 Shelves, 2 Hanger Rails	14W.x27L.	356x686	20	9.1	MBX520*
Tilt Bin 3 Units with Brackets	9 ¹ / ₂ x7 ³ / ₄ x22 ¹ / ₂	241x197x571	7	3.18	MBX543††
Tilt Bin 4 Units with Brackets	8 ¹ / ₈ x6 ¹ / ₂ x22 ¹ / ₂	206x165x571	6	2.73	MBX544††
Tilt Bin 5 Units with Brackets	6 ¹ / ₂ x5 ¹ / ₂ x22 ¹ / ₂	165x133x571	4	1.82	MBX545††
Tilt Bin 6 Units with Brackets	4 ¹ / ₂ x5 ¹ / ₄ x22 ¹ / ₂	114x133x571	3	1.37	MBX546††
Tape Dispenser/Counter Top Model			5	2.28	MBA580
Tape Dispenser with 2 Brackets for Overbridge	4x4x11	102x102x279	6	2.73	MBA583
Divided Organizer with Lid and Brackets	2 ¹ / ₄ x7 ¹ / ₈ x7 ¹ / ₈	57x181x181	2	.91	MBA586
Overbridge with 1 Swivel Shelf, 2 Hanger Rails	14W.x27L.	356x686	26	11.83	MBX615*†
Overbridge with 2 Shelves (Top Swivel), 1 Hanger Rail	14W.x27L.	356x686	30	13.65	MBX620*†

*75 lbs. (35kg) weight capacity
 †Shelf swivels 360 degrees.
 ††Mounts to overbridge rail (ordered separately).

MBX209



MBA215, MBX250



MBA586



MBA243



MBA244



MBA245



MBA246



MBX511, MBX545, MBX546



MBX515, MBX545

BASIX COMPACT CARTS

Compact Carts

18¹/₂" D. x 19¹/₄" L. x 34¹/₂" H. (470x489x876mm)

Drawer Space	Drawer Configuration	Color	Lock	Approx. Pkd. Wt. (lbs.) (kg)		Cat. No.*
24" (610mm)	3 - 3" (76mm)	Two Tone	Key Lock	133	63	MBC3110TL*
	1 - 6" (152mm)					
	1 - 9" (230mm)					
24" (610mm)	1 - 3" (76mm)	Two Tone	Key Lock	133	63	MBC1210TL*
	2 - 6" (152mm)					
	1 - 9" (230mm)					

*Note: Drawer color and solid cart body color is specified by ordering the desired color/code

*Available in solid body color.

Build-A-Cart

Cart Body — 34¹/₂" H. (876mm)

Drawer Space	Drawer Configuration	Color	Lock	Width (in.) (mm)		Length (in.) (mm)		Cat. No.*
24" (610mm)	Empty	Two Tone	Key Lock	18 ¹ / ₂	470	19 ¹ / ₄	489	MBC24TL*

*Note: Drawer color and solid cart body color is specified by ordering the desired color/code



Cart: MBC3110TL
Color: MBC-LA (Lavender)
Two Tone

Drawers

Description	Wt. Capacity† (lbs.) (kg)		Height (in.) (mm)		Depth (in.) (mm)		Length (in.) (mm)		Cat. No.*
3" (76mm) Deep Steel Drawer	15	7	2 ⁷ / ₈	73	17	432	15	381	MBC103
6" (152mm) Deep Steel Drawer	15	7	6 ¹ / ₄	159	17	432	15	381	MBC106
9" (230mm) Deep Steel Drawer	15	7	9 ³ / ₈	238	17	432	15	381	MBC109

†Drawer capacity is determined by cart stability when drawers are fully extended.

*Note: Drawer color and solid cart body color is specified by ordering the desired color/code



MBX208



MBA586



MBA215, MBX250



MBA221



Cart: MBC1210TL
Color: MBC-DT (Dark Taupe)
Two Tone

A color code must be included with each cart/drawer ordered. The color code determines the color of the drawer and, on solid carts, the color of the cart. The quantity should equal the total number of carts.



Cat. No. MBC-BG Blue Gray	Cat. No. MBC-CB Crash Cart Blue	Cat. No. MBC-CR Cranberry	Cat. No. MBC-DB Dark Blue	Cat. No. MBC-DT Dark Taupe	Cat. No. MBC-HG Hunter Green	Cat. No. MBC-LA Lavender	Cat. No. MBC-LT Light Taupe	Cat. No. MBC-MA Mauve	Cat. No. MBC-RE Red	Cat. No. MBC-SB Slate Blue	Cat. No. MBC-SG Sea Foam Green	Cat. No. MBC-TE Teal	Cat. No. MBC-YE Yellow
-------------------------------------	---	-------------------------------------	-------------------------------------	--------------------------------------	--	------------------------------------	---------------------------------------	---------------------------------	-------------------------------	--------------------------------------	--	--------------------------------	----------------------------------

Drawer Accessories



MBC113



MBC150



MBC151



MBC207



MBX545, MBX546



MBX230

Description	Dimensions		Approx.		Cat. No.
	Height/Width/Length (in.)	(mm)	Pkd. Wt. (lbs.)	(kg)	
3" (76mm) Flexible Drawer Divider Kit 4 Perimeter Rails, 2 Long, 5 Short Dividers Additional Short Divider (1 pc.) for MBC113 Additional Long Divider (1 pc.) for MBC113			1	.455	MBC113 MBA114 MBA115
6" (152mm) Flexible Drawer Divider Kit 4 Perimeter Rails, 2 Long, 5 Short Dividers Additional Short Divider (1 pc.) for MBC116 Additional Long Divider (1 pc.) for MBC116			1	.455	MBC116 MBA117 MBA118
3" (76mm) Fixed Drawer Divider Kit 2 Rails, 4 Front-to-Back Dividers			1	.455	MBC123
9" (203mm) Fixed Drawer Divider Kit 2 Rails, 4 Front-to-Back Dividers			4	1.82	MBC129
3" (76mm) Drawer Tray 2 Long, 4 Short, 10 Ampule Dividers	3x14x16	76x356x406	4	1.82	MBC150
3" (76mm) Drawer Tray 2 Long, 5 Short Dividers	3x14x16	76x356x406	4	1.82	MBC151

Cart Accessories

Description	Dimensions		Approx.		Cat. No.
	Height/Width/Length (in.)	(mm)	Pkd. Wt. (lbs.)	(kg)	
Accessory Bar Bracket	18H.	457H.	1	.455	MBX205*
Side Handle, Tubular	18H.	457H.	2	.91	MBC207
Utility Hooks (2 per Package)	2 ¹ / ₄ x1x1 ¹ / ₂	57x25x13	1	.455	MBX208
Compact Cart Rail			4	1.82	MBC210
Glove Box Holder	10x3 ³ / ₄ x5 ³ / ₄	254x95x146	2	.91	MBA215
Wire Basket	13x10x3 ¹ / ₂		1	.455	MBA218*
Waste Container with Lift Top (20 Quart)	18x14x10	457x356x254	3	1.37	MBA220*
Waste Container — No Top (28 Quart)	15 ¹ / ₄ x14 ³ / ₈ x10 ¹ / ₄	387x365x260	3	1.37	MBA221*
Side Shelf	14 ⁷ / ₈ L.x17 ³ / ₄ W.	378L.x451W.	8	3.64	MBX230**
Catheter Holder, Short 19" (482mm)	19x4x8	482x102x203	8	3.64	MBA241
Catheter Holder, Short 19" (482mm) — Clear Front	19x4x4	482x102x102	8	3.64	MBA242
Catheter Holder, Long 28" (711mm)	28x4x8	711x102x203	8	3.64	MBA243
Catheter Holder, Long 28" (711mm) — Clear Front	28x4x4	711x102x102	8	3.64	MBA244
Sharps Bracket			2	.91	MBX250
I.V. Pole			4	1.82	MBA667

*MBX205 required for side attachment of wire basket and waste baskets.

**25lbs. (12kg) weight capacity.

Overbridge & Accessories

Description	Dimensions		Approx.		Cat. No.
	Height/Width/Length (in.)	(mm)	Pkd. Wt. (lbs.)	(kg)	
Trellis, 3 tier (For Mini Cart)	18x22	457x559	6	2.73	MBC511
Trellis, 3 tier with Hook for Mini Cart	18x22	457x559	6	2.73	MBC512
Tape Dispenser with 2 Brackets for Trellis	4x4x11	102x102x279	6	2.73	MBA583
Divided Organizer with Lid and Brackets	2 ¹ / ₄ x7 ¹ / ₈ x7 ¹ / ₈	57x181x181	2	.91	MBA586



MBA583



MBA218



MBC511, MBX544



MetroCarts™
Advancing the
way you work.



METRO.COM



LIONVILLE.COM



FLOHEALTHCARE.COM

U.S. CUSTOMER SERVICE
Phone: 1.800.992.1776
Fax (PA): 1.800.638.9263
Fax: (CA): 1.800.638.3292

CANADA CUSTOMER SERVICE
Phone: 1.905.676.9890
Fax: 1.905.676.9262

PRODUCT
INFORMATION/LITERATURE
(U.S. and Canada Only):
U.S./Canadian Toll-Free
Phone: 1.800.433.2232

DISTRIBUTION CENTERS
California
9393 Arrow Highway
Cucamonga, CA 91730

Pennsylvania
Thomas & Second Streets
Wilkes-Barre, PA 18705

Tennessee
1001 Centre Pointe Drive
LaVergne, TN 37086

Canada
Metropolitan Wire (Canada) LTD.
3160 Orlando Drive
Mississauga, Ontario
Canada L4V 1R5

InterMetro European
Distribution Center
De Riemsdijk 1
4004 LC Tiel
The Netherlands

INTERNATIONAL SALES/
CUSTOMER SERVICE OFFICES
Asia/Pacific
Metro International Corporation
27 International Business Park,
Unit #05-02 iQuest @ IBP
Singapore 609924
Phone: 65.6567 8003
Fax: 65.6567 9003

Middle East/Africa
InterMetro Industries Corporation
P.O. BOX: 17034
Jebel Ali Free Zone
Dubai-United Arab Emirates
Phone: 009714 8118286
fax: 009714 886 5465

Europe
InterMetro Industries B.V.
Heerbaan 242
4817 NL Breda
Breda
The Netherlands
Phone: 00.31.(0).76.587.7550
Fax: 00.31.(0).76.581.1313

Latin America
Metro International Corporation
16562 83rd Place North
Loxahatchee, FL 33470
Phone: 1.561.333.3824
Fax: 1.561.792.6351

CORPORATE HEADQUARTERS
651 North Washington Street
Wilkes-Barre, PA 18705
Phone: 1.570.825.2741
Fax: 1.570.825.2852

L06-112E



We put space to work.™

Information and specifications are subject to change without notice. Please confirm at time of order.

© 2009 InterMetro Industries Corporation, Wilkes-Barre, PA 18705
The Emerson logo is a trademark and a service mark of Emerson Electric Company.



EMERSON™